

#DEJAMOSHUELLA

DISTRIBUIDORA DE LÁMINAS
EL TIGRE
SA DE CV



MR

"TU ALIADO CONFIABLE EN TUS
PROYECTOS DE CONSTRUCCION"

CATÁLOGO
de Productos

www.laminaseltigre.com



Ternium



WDE JAMOSHUELLA

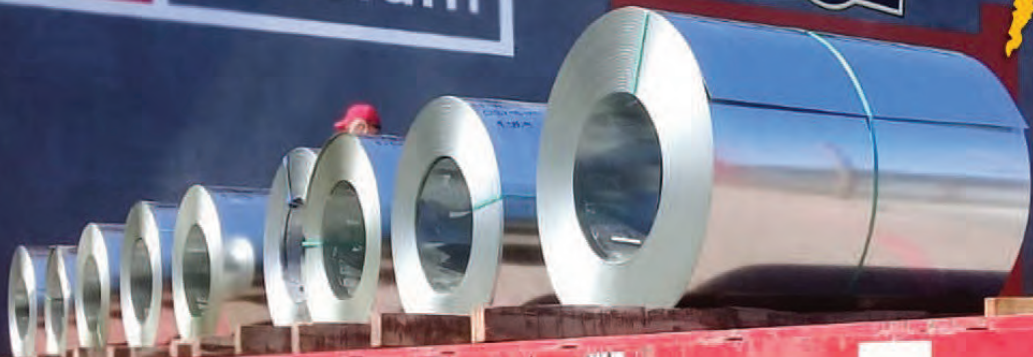

Gracias a la confianza de nuestros clientes hemos participado en los proyectos de las siguientes empresas :



VOLVO



JOHN DEERE



Soriana

JUMEX



MISIÓN, VISIÓN Y VALORES

www.laminaseltigre.com 800-35-84473 81-83-14-16-10



MISIÓN

Somos una empresa dedicada a la transformación de productos de acero galvanizado, comprometida a trabajar en equipo para responder de manera ágil a las necesidades de nuestros clientes con los más altos estándares de calidad, atención y servicio.

VISIÓN

Ser una empresa de clase mundial en la transformación de productos de acero galvanizado.

VALORES

- Integridad
- Responsabilidad
- Trabajo en equipo
- Confianza
- Compromiso

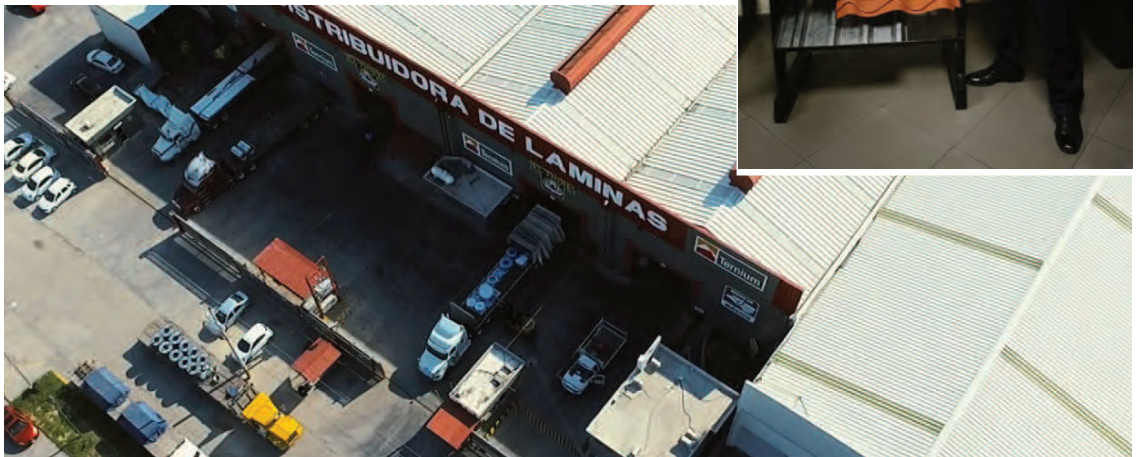

ÍNDICE

www.laminasetigre.com 800-35-84473 81-83-14-16-10



ROLLO	6
CINTA	7
HOJA LISA	8
LÁMINA TIGRE -R101 Y TIGRE R-72	9
LÁMINA TIGRE RN-100	10
LÁMINA TIGRE O-100 Y TIGRE O-72	11
LÁMINA TIGRE-LOSA 25 (ROLADA)	12
LÁMINA TIGRE-LOSA 15	13
LÁMINA TIGRE RD-91.5	14
LÁMINA TIGRE-LOSA 30	15
LÁMINA TIGRE-LOSA 3N	16
GALVATEJA (TERNIUM)	17
ACCESORIOS GALVATEJA (TERNIUM)	18
LÁMINA TIGRE-TEJA	19
LÁMINA TIGRE KR-18	20
CLIP PARA KR-18	21
TIGRE-POSTE METÁLICO LIGERO Y ESTRUCTURAL	22
TIGRE-CANAL METÁLICO LIGERO Y ESTRUCTURAL	23
ACCESORIOS METÁLICOS LIGEROS Y ESTRUCTURALES. PARA SU CONSTRUCCIÓN	24-25
TIGRE-UNICANAL	26
LÁMINA TRANSLUCIDA ACRÍLICA	27
LÁMINA TRANSLUCIDA POLIESTER	28
TIGRE-POLIN TIPO C Y Z	29-30
TIGRE-PTR	31-34
TIGRE-HSS	35-37
TIGRE-PLACA	38

ÍNDICE

www.laminasetigre.com 800-35-84473 81-83-14-16-10



TIGRE-ANTIDERRAPANTE	39
TIGRE-ANGULO	40-41
TIGRE-SOLERA	42-43
TIGRE-REDONDO	44
TIGRE-CANAL	45
TIGRE-VIGA	46-50
TIGRE-TUBO	51
TIGRE-INOXIDABLE	52
TIGRE-VARILLA	53
MULTYPANEL DE TECHO Y MURO	54
COLCHONETA DE FIBRA DE VIDRIO CABALLETE	55
LISO	56
TABLA DE PESOS	57
PESOS, MEDIDAS Y FACTORES DE CONVERSIÓN	58
RECOMENDACIONES	59

ROLLO

www.laminaseltigre.com 800-35-84473 81-83-14-16-10



DESCRIPCIÓN

Producto galvanizado por medio del proceso de inmersión en caliente continuo que cumple con la Norma ASTM A653

CARACTERÍSTICAS DEL PRODUCTO

- Disponible en cal. 12 al 32 en acabado galvanizado
- Disponible en cal. 22 al 32 en acabado zintroalum
- Disponible en cal. 18 al 26 en acabado pintado
- Colores disponibles de línea : blanco estándar, arena estándar, rojo Janitzio, verde teja, azul estándar.
- Si requiere un color distinto a los mencionados, favor de consultar con su vendedor

COLORES

- Azul estándar



- Rojo janitzio



- Verde teja



- Blanco estándar



- Arena estándar



CINTA

www.laminaseltigre.com 800-35-84473 81-83-14-16-10



DESCRIPCIÓN

Producto galvanizado por medio del proceso de inmersión en caliente continuo que cumple con la Norma ASTM A653.

CARACTERÍSTICAS DEL PRODUCTO

- Disponible en medida de 2" a 24"
- Disponible en cal. 12 al 30 en acabado galvanizado
- Disponible en cal. 22 al 26 en acabado pintado



HOJA LISA

www.laminasetigre.com 800-35-84473 81-83-14-16-10



DESCRIPCIÓN

La lámina lisa de acero galvanizado, zintro-alum o pintado es un tipo de producto orientado para uso en los sectores de construcción y arquitectura, además de que se puede usar como elemento principal para la creación de manufacturas y en la fabricación de accesorios arquitectónicos necesarios para la instalación de láminas acanaladas.

CARACTERÍSTICAS DEL PRODUCTO

CALIBRES Y ACABADOS			
CALIBRE	GALVANIZADO	Z-ALUM	PINTRO
10	✓		
12	✓		
14	✓		
16	✓		
18	✓		✓
20	✓	✓	✓
22	✓	✓	✓
24	✓	✓	✓
26	✓	✓	✓
28	✓	✓	
30	✓	✓	
32	✓	✓	

COLORES

- Azul estándar 
- Rojo janitzio 
- Verde teja 
- Blanco estándar 
- Arena estándar 



LÁMINA TIGRE-R101 Y TIGRE R-72

www.laminaseltigre.com 800-35-84473 81-83-14-16-10



DESCRIPCIÓN

Perfil acanalado de configuración trapecoidal diseñado para ser utilizado como cubierta de fijación expuesta.

CARACTERÍSTICAS DEL PRODUCTO

- Disponible para R-101 en cal. 20, 22, 24, 26 y 28.
- Disponible para R-72 en cal. 20, 22, 24, 26, 28, 30 y 32.
- Disponible en acabado galvanizado, zintroalum y pintado.
- Colores disponibles de línea : cara exterior blanco estándar, arena estándar, rojo janitzio, verde teja, todos con cara inferior fondo gris. Si requiere un color distinto a los mencionados, favor de consultar con su vendedor.
- Disponible con una longitud mínima de 30 cm hasta 13.00 mt.
- Traslape longitudinal mínimo sugerido 20 cm.
- Pendiente mínima sugerida 10%, longitud máxima de vertiente sugerida 20 mt.

ANCHO REAL (DE PUNTA A PUNTA)

R-72	80.30 cm
R-101	107 cm

ANCHO EFECTIVO (PODER CUBRIENTE)

R-72	71.20 cm (28.03")
R-101	100.01 cm (39.37")

TABLA DE PESOS

KILO POR METRO LINEAL

	3' (R-72)	4' (R-101)
CAL. 20	6.797	9.062
CAL. 22	5.703	7.603
CAL. 24	4.062	5.416
CAL. 26	3.515	4.686

KILO POR METRO LINEAL

	3' (R-72)	4' (R-101)
CAL. 28	2.968	3.957
CAL. 30	2.439	
CAL. 32	2.020	

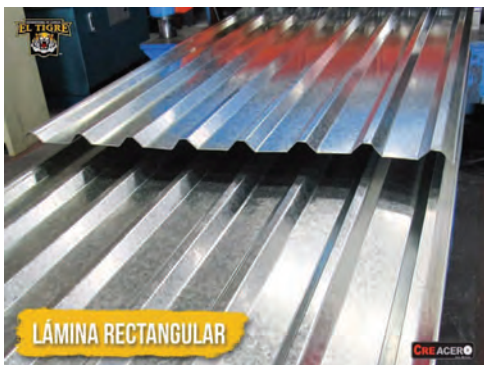

R - 72

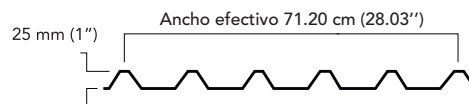

R - 101

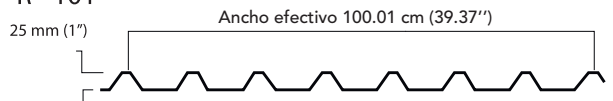

EJEMPLO DE TRASLAPE TRANSVERSAL



LÁMINA TIGRE RN-100

www.laminaseltigre.com 800-35-84473 81-83-14-16-10

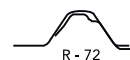

DESCRIPCIÓN

Lámina ideal para cubiertas o fachadas de naves industriales donde se requiere resistencia estructural y/o diseño con pendientes bajas.

CARACTERÍSTICAS DEL PRODUCTO

- Disponible en cal. 22, 24 y 26.
- Disponible en acabado galvanizado, zintroalum y pintado.
- Colores disponibles de línea : cara exterior blanco estándar, arena estándar, rojo janitzio, verde teja, todos con cara inferior fondo gris. Si requiere un color distinto a los mencionados, favor de consultar con su vendedor.
- Disponible con una longitud mínima de 30 cm hasta 13.00 mt.
- Doble canal antisifón, por lo tanto posee excelente capacidad de drenaje.
- Traslape longitudinal mínimo sugerido 20 cm.
- Pendiente mínima sugerida 6%, longitud máxima de vertiente sugerida 25 mt.

ANCHO REAL
(DE PUNTA A PUNTA)

RN-100 106 cm

ANCHO EFECTIVO
(PODER CUBRIENTE)

RN-100 100 cm

TABLA DE PESOS

KILO POR METRO LINEAL

4' (RN-100)

CAL. 22 7.603

CAL. 24 5.416

CAL. 26 4.686



LÁMINA TIGRE O-100 Y TIGRE O-72

www.laminasetigre.com 800-35-84473 81-83-14-16-10

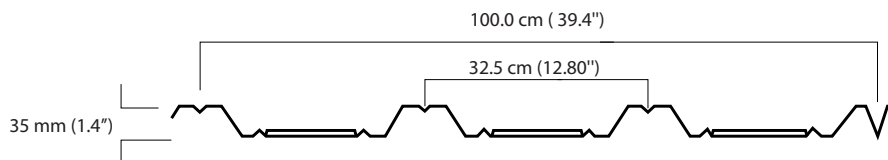

DESCRIPCIÓN

Perfil ondular el cual es el único que tiene la cualidad de poder ser utilizado en techos curvos.

CARACTERÍSTICAS DEL PRODUCTO

- Disponible para O-100 en cal. 22, 24, 26 y 28.
- Disponible para O-72 en cal. 22, 24, 26, 28, 30 y 32.
- Disponible en acabado galvanizado, zintroalum y pintado.
- Colores disponibles de línea : cara exterior blanco estándar, arena estándar, rojo janitzio, verde teja, todos con cara inferior fondo gris. Si requiere un color distinto a los mencionados, favor de consultar con su vendedor.
- Disponible con una longitud mínima de 30 cm hasta 13.00 mt.
- Traslape longitudinal mínimo sugerido 20 cm.
- Pendiente mínima sugerida 10%, longitud máxima de vertiente sugerida 15 mt.

ANCHO REAL (DE PUNTA A PUNTA)

O-72	83 cm
O-100	111 cm

ANCHO EFECTIVO (PODER CUBRIENTE)

O-72	72 cm
O-100	104 cm (muro)
	96 cm (techo)

TABLA DE PESOS

KILO POR METRO LINEAL

	3' (O-72)	4' (O-100)
CAL. 22	5.703	7.603
CAL. 24	4.062	5.416
CAL. 26	3.515	4.686
CAL. 28	2.968	3.957
CAL. 30	2.439	
CAL. 32	2.020	

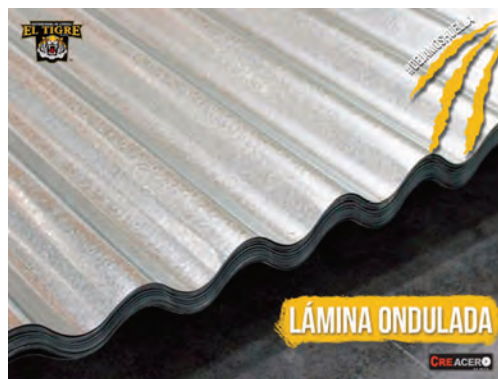

O-725

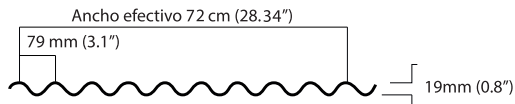

O-100

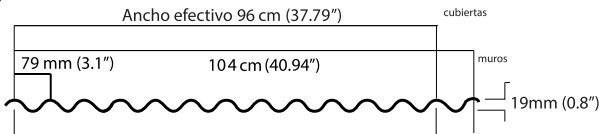

EJEMPLOS DE TRASLAPE TRANSVERSAL



LÁMINA TIGRE-LOSA 25

www.laminasetigre.com 800-35-84473 81-83-14-16-10

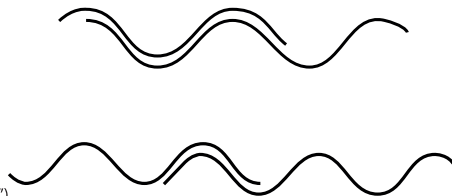

DESCRIPCIÓN

Sistema de entrepiso metálico que utiliza un perfil laminado, diseñado para anclar perfectamente con el concreto y formar la losa de azotea.

CARACTERÍSTICAS DEL PRODUCTO

- Disponible en cal. 20, 22 y 24.
- Disponible en acabado galvanizado, zintroalum y pintado.
- Disponible con una longitud mínima de 1.00 mt hasta 13.00 mt.
- Este sistema, además de tener una excelente resistencia estructural, disminuye los tiempos de construcción generando ahorros en mano de obra, tiempo y renta de equipo.
- Reemplaza la cimbra de madera convencional.
- Los relieves longitudinales en los paneles de cada canal de la losacero actúan como conectores mecánicos que la unen al concreto, evitando la separación vertical.

ANCHO REAL
(DE PUNTA A PUNTA)

LOSACERO 25
rolada **94.5 cm**

ANCHO EFECTIVO
(PODER CUBRIENTE)

LOSACERO 25
rolada **92 cm**

TABLA DE PESOS

KILO POR METRO LINEAL
LOSACERO 25

CAL. 20	9.062
CAL. 22	7.603
CAL. 24	5.416



LÁMINA TIGRE-LOSA 15

www.laminaseltigre.com 800-35-84473 81-83-14-16-10

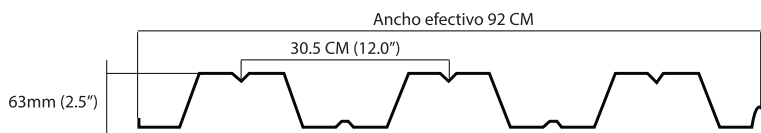
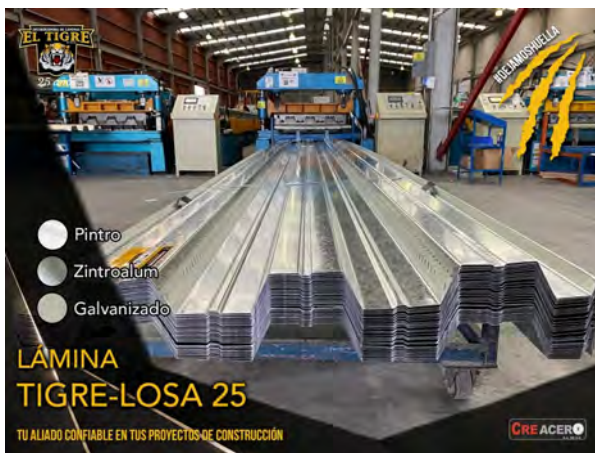

DESCRIPCIÓN

Sistema de entrepiso metálico que utiliza un perfil laminado, diseñado para anclar perfectamente con el concreto y formar la losa de azotea.

CARACTERÍSTICAS DEL PRODUCTO

- Disponible en cal. 18, 20, 22 y 24.
- Disponible en acabado galvanizado y pintado.
- Disponible con una longitud mínima de 1.83 mt hasta 12 mt.
- Este sistema, además de tener una excelente resistencia estructural, disminuye los tiempos de construcción generando ahorros en mano de obra, tiempo y renta de equipo.
- Reemplaza la cimbra de madera convencional.
- Los relieves longitudinales en los paneles de cada canal de la losacero actúan como conectores mecánicos que la unen al concreto, evitando la separación vertical.

ANCHO REAL
(DE PUNTA A PUNTA)

LOSACERO 15 95 cm

ANCHO EFECTIVO
(PODER CUBRIENTE)

LOSACERO 15 91.5 cm

TABLA DE PESOS

KILO POR METRO LINEAL
LOSACERO 15

CAL. 20	9.062
CAL. 22	7.603
CAL. 24	5.416



Ancho efectivo 91.5 CM (36.0")



LÁMINA TIGRE RD-91.5

www.laminaseltigre.com 800-35-84473 81-83-14-16-10



DESCRIPCIÓN

Lamina que puede utilizarse como cubierta compuesta o fchachada. Tienen excelente capacidad estructural y es estibable

CARACTERÍSTICAS DEL PRODUCTO

- Disponible en cal. 20, 22 y 24
- Disponible en acabado galvanizado y pintado
- Colores disponible: blanco estándar. Si requiere un color distinto, favor de consultar con su vendedor
- Disponible con una longitud mínima de 1.22 mt hasta 13.00 mt
- Traslape longitudinal mínimo sugerido 25 cm

TABLA DE PESOS

KILO POR METRO LINEAL

4'

CAL.20	9.062
CAL.22	7.603
CAL.24	5.416

ANCHO REAL
(DE PUNTA A PUNTA)

RD-91.5 94.00 cm

ANCHO EFECTIVO
(PODER CUBRIENTE)

RD-91.5 91.50 cm

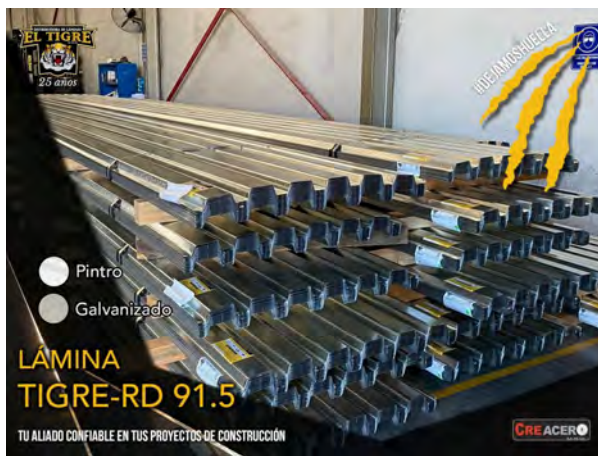

LAMINA TIGRE-LOSA 30

www.laminaseltigre.com 800-35-84473 81-83-14-16-10



DESCRIPCIÓN

Los relieves longitudinales en los paneles de cada canal de la losacero actúan como conectores mecánicos que unen al concreto, evitando la separación vertical.

Sistema de entrepiso metálico que utiliza un perfil laminado, diseñado para anclar perfectamente con el concreto y formar la losa de azotea.

CARACTERÍSTICAS DEL PRODUCTO

- Disponible en cal. 18, 20, 22 y 24
- Disponible en acabado galvanizado zintroalum y pintado
- Disponible con un ancho real de 92.5 y ancho efectivo de 91.5
- Disponible con una longitud en un rango de: 1 m - 13 m



TABLA DE PESOS

KILO POR METRO LINEAL

CAL. 18	11.955 KG
CAL. 20	9.062 KG
CAL. 22	7.603 KG
CAL. 24	5.416 KG

***Este sistema, además de tener una excelente resistencia estructural, disminuye los tiempos de construcción generando ahorros en mano de obra, tiempo y renta de equipo.**

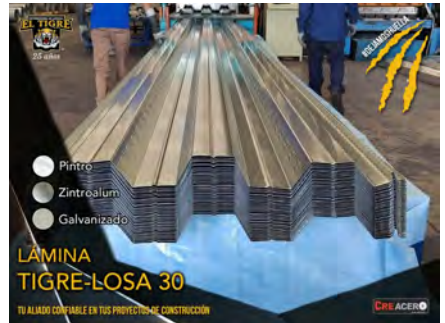

LÁMINA DECK 3N

www.laminaseltigre.com 800-35-84473 81-83-14-16-10

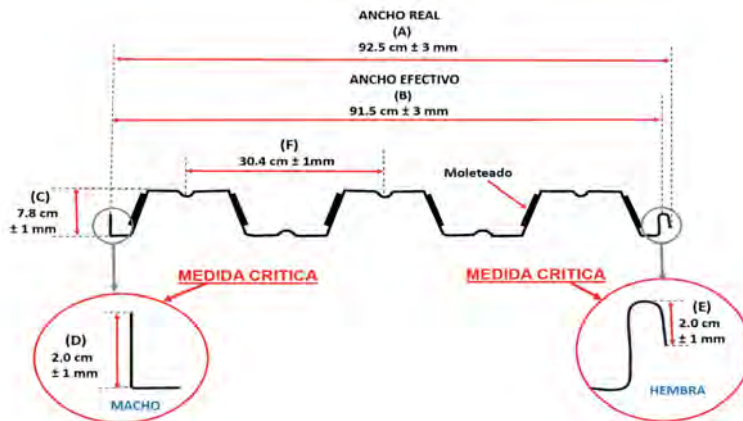

DESCRIPCIÓN

Gracias a su alta capacidad de carga permite aumentar la separación entre apoyos intermedios disminuyendo el costo total de su proyecto.

Ideal en la instalación de techos (compuestos), con aplicación en la construcción de naves industriales, edificios y centros comerciales.

CARACTERÍSTICAS DEL PRODUCTO

- Disponible en cal. 18, 20 y 22
- Disponible en acabado galvanizado y pintado
- Disponible con un ancho efectivo de 24" (60.9 cm)
- Disponible con una longitud en un rango de: 50 cm - 14 m

TABLA DE PESOS

KILO POR METRO LINEAL

CAL. 18	10.15 Kg/ML
CAL. 20	7.69 Kg/ML
CAL. 22	6.45 Kg/ML

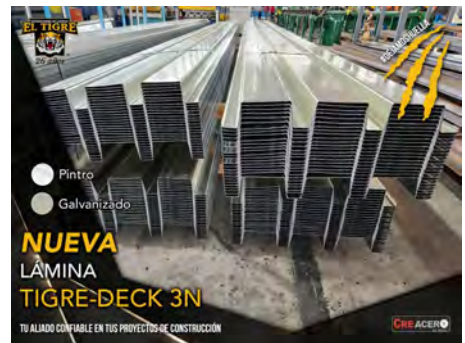

*Producido en calibres 18, 20 y 22, en dimensiones estandares o de acuerdo a las necesidades del proyecto.

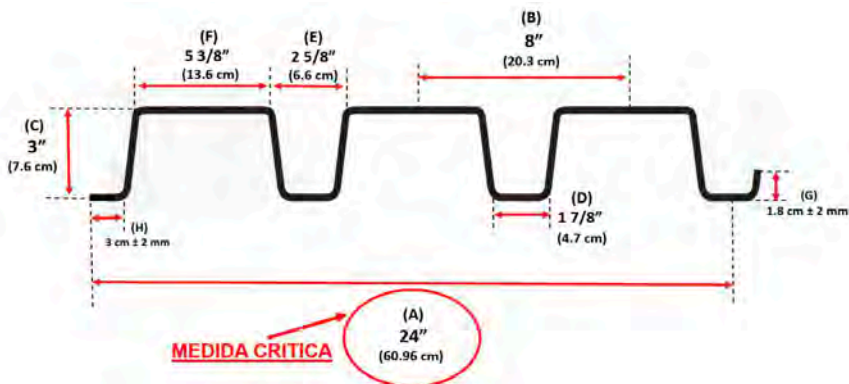

GALVATEJA (TERNIUM)

www.laminaseltigre.com 800-35-84473 81-83-14-16-10



DESCRIPCIÓN

Producto fabricado en lámina de acero galvanizado y posteriormente pintado, de apariencia a la teja tradicional con la durabilidad del acero recubierto.

CARACTERÍSTICAS DEL PRODUCTO

- Diseño de teja tipo española.
- Disponible en cal. 26 en color rojo Janitzio por ambos lados.
- Disponible con una longitud mínima de 1.22 mt hasta 6.10 mt en múltiplos de 2 tejas (61 cm).
- Pendiente recomendada 30%
- Puede ser instalada sobre polines de acero, paneles de madera y losa de concreto

****ESTE PRODUCTO NO FUNCIONA ESTRUCTURALMENTE COMO LOS ACANALADOS TRADICIONALES, NUESTRA RECOMENDACIÓN ES UTILIZAR APOYOS A UN MAXIMO DE 90 CM.**

ANCHO REAL
(DE PUNTA A PUNTA)

GALVATEJA 112 cm

ANCHO EFECTIVO
(PODER CUBRIENTE)

GALVATEJA 100 cm

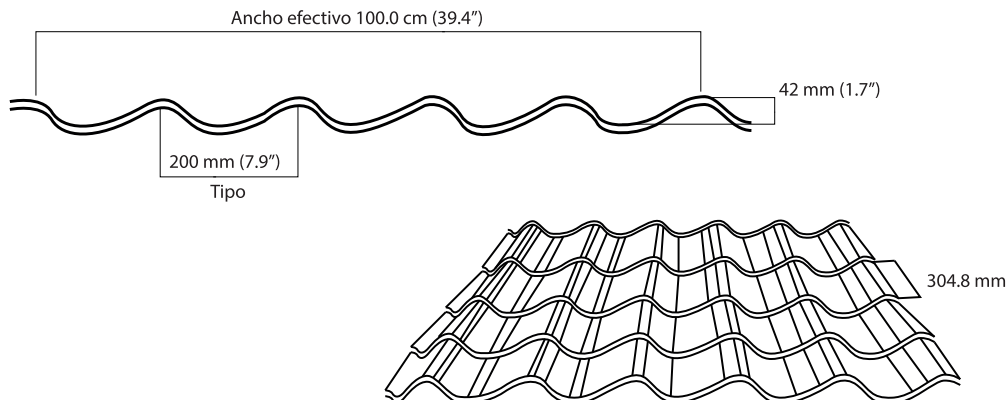

ACCESORIOS GALVATEJA (TERNIUM)

www.laminaseltigre.com 800-35-84473 81-83-14-16-10



DESCRIPCIÓN

Se manejan en un largo de 3.05 mt., a excepción del caballete que cubre 40 cm. y del remate del caballete, el cual es un semicírculo que se usa como terminación en la instalación del caballete.

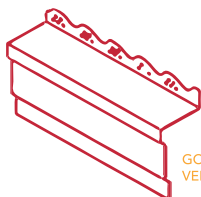

GOTERÓN MARQUESINA VENTILADO

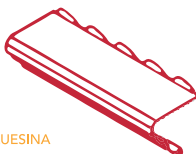

GOTERÓN VENTILADO

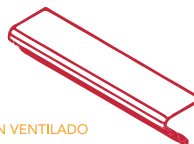

MOLDURA PECHO PALOMA

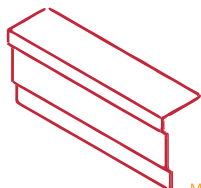

MOLDURA MARQUESINA

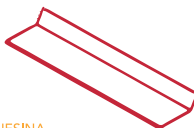

TAPA UNIÓN MURO

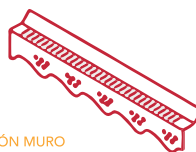

CLOSURE VENTILADO SUPERIOR

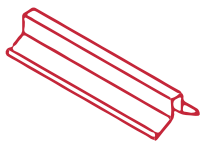

BAJO CUMBRERA PARA PARTEAGUAS

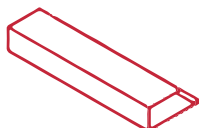

CANAL DE INICIO LATERAL



REMATE CABALLETE

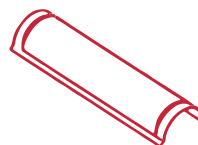

CABALLETE



HOJA LISA

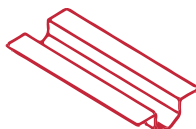

TAPA CANALON VALLE

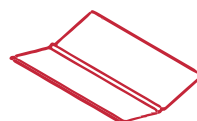

CANALON VALLE



*CLOSURE VENTILADO INFERIOR



*CANALON PECHO PALOMA



GOTERON PECHO PALOMA VENTILADO

LÁMINA TIGRE-TEJA

www.laminasetigre.com 800-35-84473 81-83-14-16-10



DESCRIPCIÓN

Producto fabricado en lámina de acero galvanizado y posteriormente pintado, de apariencia a la teja tradicional con la durabilidad del acero recubierto.

CARACTERÍSTICAS DEL PRODUCTO

- Disponible en cal. 26.
- Colores disponibles de línea: rojo / rojo, o bien, cara exterior rojo janitzio, verde teja, arena o blanco con cara inferior fondo gris. Si requiere un color distinto a los mencionados, favor de consultar con su vendedor.
- Disponible con una longitud mínima de 0.61 mt hasta 6.10 mt en múltiplos de 1 teja de 30.5 cm.
- Pendiente recomendada 30%
- Puede ser instalada sobre polines de acero, paneles de madera y losa de concreto.
- Empieza y termina en medio pie (media teja = 15.25 cm).

****ESTE PRODUCTO NO FUNCIONA ESTRUCTURALMENTE COMO LOS ACANALADOS TRADICIONALES, NUESTRA RECOMENDACIÓN ES UTILIZAR APOYOS A UN MÁXIMO DE 90 CM.**

****ESTE TIPO DE LÁMINA NO SE INSTALA IGUAL QUE LA LÁMINA RECTANGULAR, LE RECOMENDAMOS QUE SE ASESORE CON ALGUIEN QUE TENGA EXPERIENCIA EN ESTE TIPO DE INSTALACIÓN.**

ANCHO REAL
(DE PUNTA A PUNTA)

TEJA ROLADA 113 cm

ANCHO EFECTIVO
(PODER CUBRIENTE)

TEJA ROLADA 100 cm

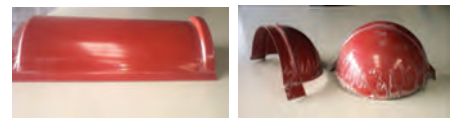

PROFUNDIDAD DE ESTAMPADO

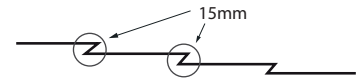

TRASLAPE



LÁMINA TIGRE KR-18

www.laminaseltigre.com 800-35-84473 81-83-14-16-10

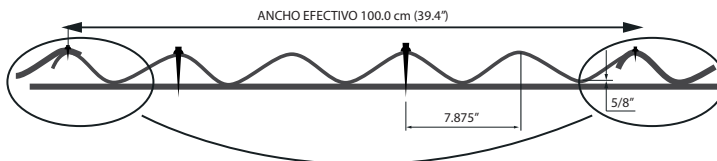

DESCRIPCIÓN

Lámina para techo fabricado generalmente en obra que proporciona la mas alta hermeticidad y no ofrece restricciones en lo largo. Sistema engargolado que requiere para su sujeción clips, los cuales quedan ocultos al realizar la unión lateral, no siendo necesario perforar las piezas para su sujeción.

CARACTERÍSTICAS DEL PRODUCTO

- Disponible en cal. 22, 24 y 26.
- Disponible en acabado galvanizado, zintroalum y pintado.
- Colores disponibles de línea : cara exterior blanco estándar con cara inferior fondo gris. Si requiere un color distinto a los mencionados, favor de consultar con su vendedor.
- Para la fabricación de este perfil se requiere utilizar lámina de acero en rollo de 24" de ancho.
- Los pesos del rollo para acanalado en obra son de aproximadamente 2,500 kg.
- Si nosotros rolamos el material en nuestras instalaciones el largo máximo es de 13.00 mt.
- Pendiente mínima recomendada 5%.
- Nosotros podemos rentarle la máquina roladora y la engargoladora de KR-18.

TABLA DE PESOS

	KR-18	
	ML	M2
CAL. 22	3.80 KG	8.44 KG
CAL. 24	2.70 KG	6.05 KG
CAL. 26	2.34 KG	5.20 KG

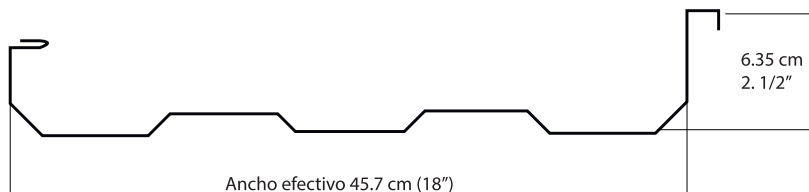
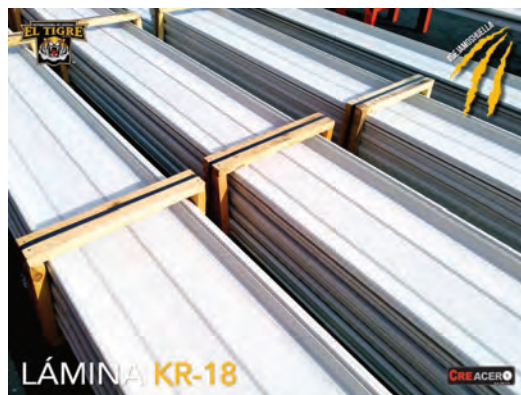

CLIP PARA KR-18

www.laminasetigre.com 800-35-84473 81-83-14-16-10



DESCRIPCIÓN

Funciona para unir la charola KR-18 con la estructura. Se maneja tanto el clip fijo y móvil de 90 grados como el clip fijo y móvil de 180 grados.

CARACTERÍSTICAS DEL PRODUCTO

- Disponible en cal. 22 y 24
- Disponible en acabado galvanizado y pintado

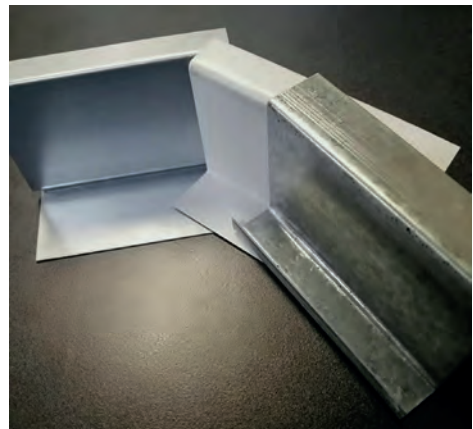
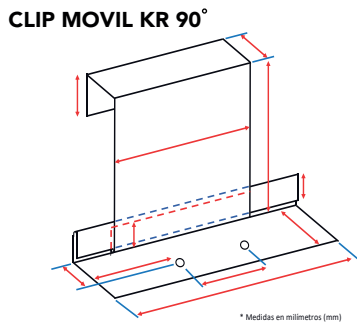
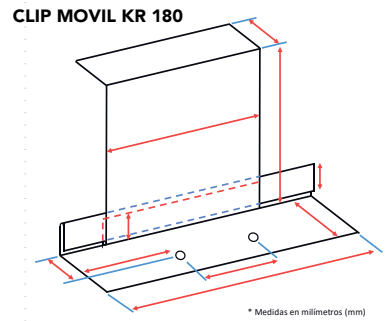
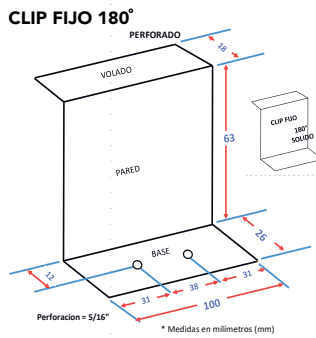
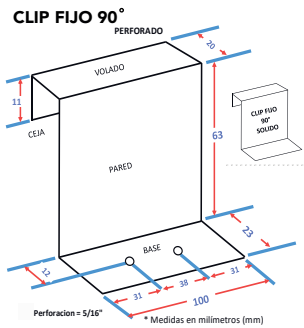

TIGRE-POSTE METÁLICO Y ESTRUCTURAL

www.laminaseltigre.com 800-35-84473 81-83-14-16-10



DESCRIPCIÓN

Poste metálico galvanizado en forma de "C" para formar bastidores, cuenta con tres perforaciones una en cada extremo y otra en el centro, para la colocación de instalaciones eléctricas, las cuales permiten el paso de tuberías y mangueras.

OBSERVACIONES

- Tolerancia de $\pm .001$ in
- Cantidad de piezas por atado: 12 (En calibre 20 los atados son de 6 pza)
- Si requiere un largo especial favor de consultar con su vendedor

PRODUCTO	CALIBRE	A	B	C	D	PESO
		PERALTE CM. (PULG)	PATÍN CM. (PULG)	PATÍN CM. (PULG)	CEJA CM. (PULG)	KG / PZ
POSTE 4.10	26	4.10 (1 5/8")	3.01 (1 3/16")	3.17 (1 1/4")	.55 (7/32")	1.24
POSTE 4.10	20	4.10 (1 5/8")	3.01 (1 3/16")	3.17 (1 1/4")	.55 (7/32")	2.41
POSTE 6.35	26	6.35 (2 1/2")	3.01 (1 3/16")	3.17 (1 1/4")	.55 (7/32")	1.52
POSTE 6.35	20	6.35 (2 1/2")	3.01 (1 3/16")	3.17 (1 1/4")	.55 (7/32")	2.95
POSTE 9.20	26	9.20 (3 5/8")	3.01 (1 3/16")	3.17 (1 1/4")	.55 (7/32")	1.85
POSTE 9.20	20	9.20 (3 5/8")	3.01 (1 3/16")	3.17 (1 1/4")	.55 (7/32")	3.61
POSTE 15.24	26	15.24 (6")	3.01 (1 3/16")	3.17 (1 1/4")	.55 (7/32")	2.67
POSTE 15.24	20	15.24 (6")	3.01 (1 3/16")	3.17 (1 1/4")	.55 (7/32")	5.19

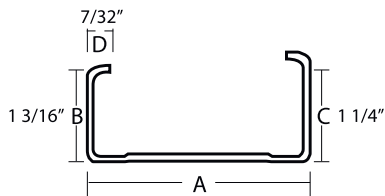
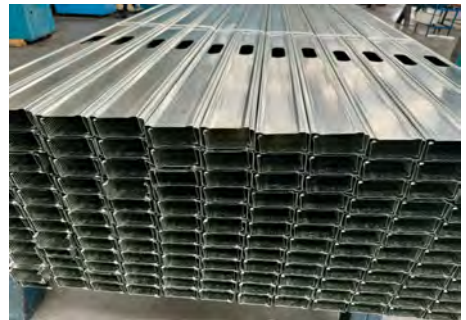

PERALTE

4.10 (1 5/8")

6.35 (2 1/2")

9.20 (3 5/8")

15.24 (6")



*Nuestros largos estandares son 3.05 Mts. (10, Ft) y 2.44 Mts (8, Ft).
*Los largos especiales se pueden fabricar a solicitud del cliente aplican restricciones.

TIGRE-CANAL METÁLICO LIGERO Y ESTRUCTURAL

www.laminaseltigre.com 800-35-84473 81-83-14-16-10



DESCRIPCIÓN

El canal amarre galvanizado en forma de "U" se utiliza para fijar muros divisorios a piso y techo. Se combina habitualmente con el Poste Metálico.

OBSERVACIONES

- Tolerancia de $\pm .001$ in
- Cantidad de piezas por atado: 12 (En calibre 22 los atados son de 6 pza)
- Si requiere un largo especial favor de consultar con su vendedor

PRODUCTO	CALIBRE	LONGITUD	A	B	PESO
		MTS (FT)	PERALTE CM. (PULG)	PATÍN CM. (PULG)	KG / PZ
CANAL 4.10	26	3.05 (10)	4.10 (1 5/8")	2.54 (1")	1.03
CANAL 4.10	22	3.05 (10)	4.10 (1 5/8")	2.54 (1")	1.69
CANAL 6.35	26	3.05 (10)	6.35 (2 1/2")	2.54 (1")	1.24
CANAL 6.35	22	3.05 (10)	6.35 (2 1/2")	2.54 (1")	2.02
CANAL 9.20	26	3.05 (10)	9.20 (3 5/8")	2.54 (1")	1.61
CANAL 9.20	22	3.05 (10)	9.20 (3 5/8")	2.54 (1")	2.62
CANAL 15.24	26	3.05 (10)	15.24 (6")	2.54 (1")	2.51
CANAL 15.24	22	3.05 (10)	15.24 (6")	2.54 (1")	4.11

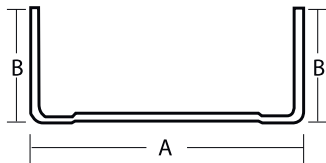
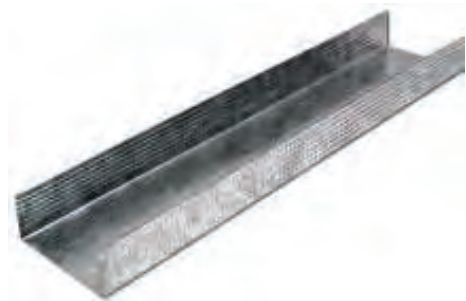

PERALTE

4.10 (1 5/8")

6.35 (2 1/2")

9.20 (3 5/8")

15.24 (6")



ACCESORIOS METÁLICOS LIGEROS Y ESTRUCTURALES PARA SU CONSTRUCCIÓN

www.laminaseltigre.com 800-35-84473 81-83-14-16-10



CANAL LISTÓN Y ESTRUCTURAL

El canal listón galvanizado forma omega, para falso plafón (Plafón corrido).



OBSERVACIONES

- Tolerancia de $\pm .001$ in
- Cantidad de piezas por atado: 20
- Si requiere un largo especial favor de consultar con su vendedor

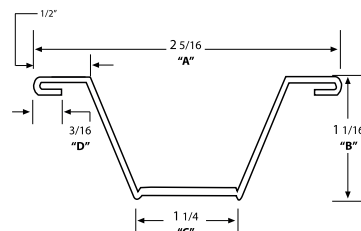

PRODUCTO	CALIBRE	LONGITUD		A	B	C	D	PESO
		MTS. (FT)	CM. (PULG)	CM. (PULG)	CM. (PULG)	CM. (PULG)	CM. (PULG)	KG / PZ
CANAL LISTÓN	26	3.05 (10')	5.87 (2 5/16")	1.75 (11/16")	3.17 (1 1/4")	.476 (3/16")		1.03
CANAL LISTÓN	20	3.05 (10')	5.87 (2 5/16")	1.75 (11/16")	3.17 (1 1/4")	.476 (3/16")		2.02
CANAL LISTÓN	22	3.05 (10')	5.87 (2 5/16")	1.75 (11/16")	3.17 (1 1/4")	.476 (3/16")		1.69

ÁNGULO DE AMARRE

El ángulo de amarre galvanizado se utiliza para marcar el perímetro o desplante del falso plafón.

OBSERVACIONES

- Tolerancia de $\pm .001$ in
- Cantidad de piezas por atado: 20
- Si requiere un largo especial favor de consultar con su vendedor

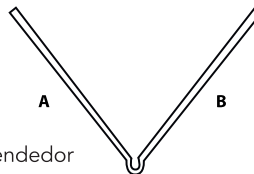

PRODUCTO	CALIBRE	LONGITUD		A	B	PESO
		MTS. (FT)	CM. (PULG)	CM. (PULG)	CM. (PULG)	KG / PZ
ÁNGULO DE AMARRE	26	3.05 (10')	2.54 (1")	2.54 (1")		0.536
ÁNGULO DE AMARRE	26	2.44 (8')	2.54 (1")	2.54 (1")		0.429

ACCESORIOS METÁLICOS LIGEROS Y ESTRUCTURALES PARA SU CONSTRUCCIÓN

www.laminaseltigre.com 800-35-84473 81-83-14-16-10



ESQUINERO

El esquinero galvanizado se utiliza para reforzar las esquinas y dar forma estética de muros y nichos.

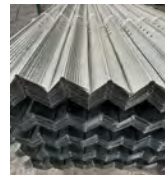

OBSERVACIONES

- Tolerancia de $\pm .001$ in
- Cantidad de piezas por atado: 20
- Si requiere un largo especial favor de consultar con su vendedor

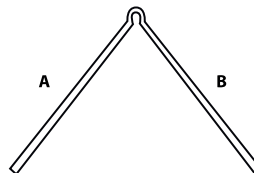

PRODUCTO	CALIBRE	LONGITUD		PESO	
		MTS. (FT)	CM. (PULG)	CM. (PULG)	KG / PZ
ESQUINERO	28	3.05 (10')	3.17 (1 1/4")	3.17 (1 1/4")	0.628
ESQUINERO	28	2.44 (8')	3.17 (1 1/4")	3.17 (1 1/4")	0.502

CANALETA DE CARGA ESTRUCTURAL

La canaleta de carga galvanizada se utiliza como soporte para el listón en el plafón.



OBSERVACIONES

- Tolerancia de $\pm .001$ in
- Cantidad de piezas por atado: 20
- Si requiere un largo especial favor de consultar con su vendedor

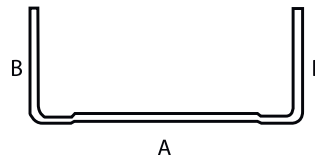

PRODUCTO	CALIBRE	LONGITUD		PESO	
		MTS. (FT)	CM. (PULG)	CM. (PULG)	KG / PZ
CANALETA DE CARGA	22	3.05 (10')	3.80 (1 1/2")	1.01 (7/16")	1.02
CANALETA DE CARGA	24	3.05 (10')	3.80 (1 1/2")	1.01 (7/16")	0.804

TIGRE-UNICANAL

www.laminaseltigre.com 800-35-84473 81-83-14-16-10



DESCRIPCIÓN

Es igual a soporte de instalación rápida a bajo costo y multifuncional. Es ideal en soportes de tuberías, instalaciones para sistemas de iluminación, soporte de charolas para cables, mesas de trabajo, armado de escenarios, etc.

En su instalación ahorra tiempo y trabajo, evitando la necesidad de soldar o taladrar en su obra.

Los Unicanales cumplen con la norma **ASTM A653**, **ASTM A153** como así también con las normas mexicanas **DNG-B-9** y **DNG-B-55** garantizando su rolado y calidad.

PRODUCTO	ANCHO	LARGO	CAL.
UNICANAL SÓLIDO Y PERFORADO	4 x 4 - 4 x 2	3.05	12
UNICANAL SÓLIDO Y PERFORADO	4 x 4 - 4 x 2	3.05	14
UNICANAL SÓLIDO Y PERFORADO	4 x 4 - 4 x 2	3.05	16
UNICANAL SÓLIDO Y PERFORADO	4 x 4 - 4 x 2	3.05	18



*El largo std. que manejamos es de 10' (120") (3.05 Mts) el largo puede ser de acuerdo a las necesidades de nuestros clientes.

*Material galvanizado en calibre 12, 14, 16 y 18

PRESENTACION SOLIDO Y PERFORADO

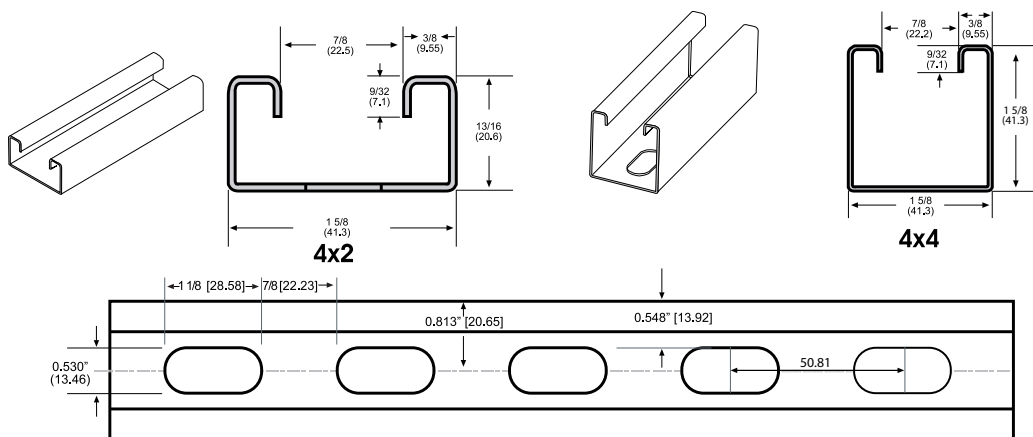

Aplica las mismas dimensiones de perforación en 4x2 y 4x4

LÁMINA TRANSLUCIDA ACRÍLICA

www.laminasetigre.com 800-35-84473 81-83-14-16-10



DESCRIPCIÓN

Este material está elaborado con resina 100% acrílica reforzado con fibra de vidrio. El espesor en los acanalados estándar es 1.4 mm, en los estructurales 1.6 mm y el doble grueso es de 2.4 mm. Gran difusor de luz, lo que permite un ahorro de energía eléctrica. Conserva su color original por mas tiempo, tiene garantía de stabilit por 18 años de duración.

GAMA DE PERFILES



LÁMINA TRANSLUCIDA POLIÉSTER

www.laminaseltigre.com 800-35-84473 81-83-14-16-10

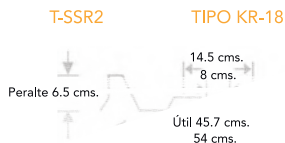
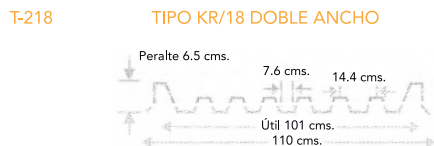
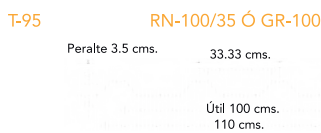
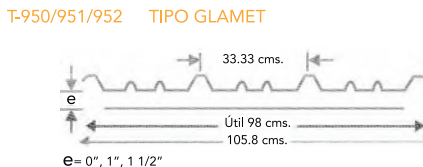
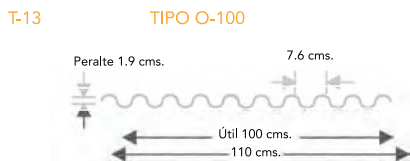
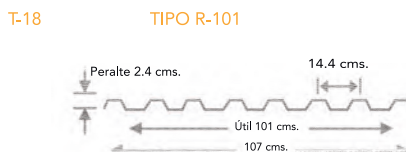
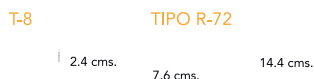

DESCRIPCIÓN

Laminado plástico translúcido, elaborado con resina de poliéster y acrílica reforzados con fibra de vidrio. El espesor en los acanalados estándar es 1.2 mm, en los estructurales 1.4 mm y el doble grueso es de 2.2 mm. Permite la transmisión de luz, tiene garantía de stabilit por 10 años de duración.

GAMA DE PERFILES

T-80

TIPO R-72

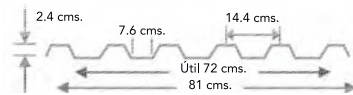

T-81

TIPO R-101

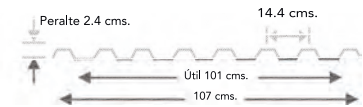

T-13

TIPO O-100

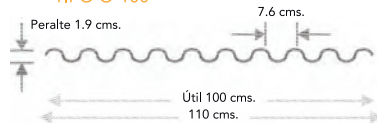

T-60

TIPO O-30

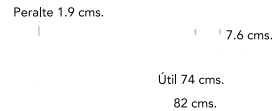

T-95

TIPO RN-100/35 Ó GR-100

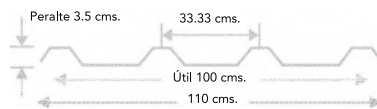

T-SSR2

TIPO KR-18

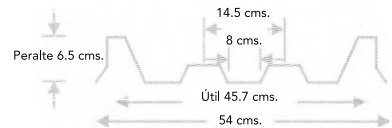

T-218

TIPO KR-18

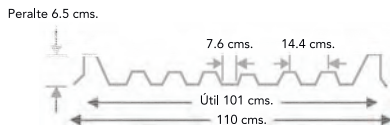

PERFILES TIPO ASBESTO / CEMENTO

T-57

TIPO 6 ONDAS / ASBESTO

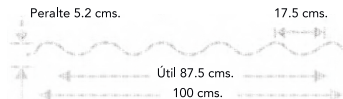

T-50

PLANA Y LISA

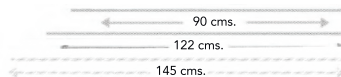

T-10

TIPO ESTRUCTURAL / ASBESTO

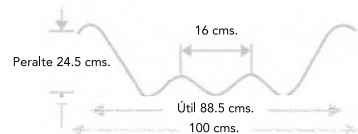

TIGRE-POLIN

TIPO C Y Z

www.laminaseltigre.com 800-35-84473 81-83-14-16-10



TABLA DE PESOS

Tipo	Dimensión exterior	Calibre	Longitud	Peso
	<i>Pulg.</i>		<i>(m.)</i>	<i>Kg./m.</i>
3EP14	3 x 1 1/2	14	6	2.61
3EP16	3 x 1 1/2	16	6	2.08
4EP10	4 x 1 1/2	10	6	5.20
4EP12	4 x 1 1/2	12	6	4.20
4EP14	4 x 1 1/2	14	6	2.96
4EP16	4 x 1 1/2	16	6	2.40
4EP10	4 x 2	10	4, 5 y 6	5.90
4EP12	4 x 2	12	4, 5 y 6	4.80
4EP14	4 x 2	14	4, 5 y 6	3.40
4EP16	4 x 2	16	4, 5 y 6	2.71
5EP10	5 x 2	10	5 y 6	6.60
5EP12	5 x 2	12	5 y 6	5.30
5EP14	5 x 2	14	5 y 6	3.80
5EP16	5 x 2	16	5 y 6	3.00
6EP10	6 x 2	10	6	7.30
6EP12	6 x 2	12	6	5.86
6EP14	6 x 2	14	6	4.19
6EP16	6 x 2	16	6	3.30
7EP10	7 x 2 3/4	10	7	9.20
7EP14	7 x 2 3/4	14	7	5.30
7EP16	7 x 2 3/4	16	7	4.20
8EP10	8 x 2 3/4	10	8	9.90

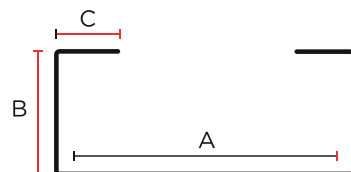

Tipo "C"



Tipo "Z"

TIGRE-POLIN

TIPO C Y Z

www.laminaseltigre.com 800-35-84473 81-83-14-16-10



Tipo	Dimensión exterior	Calibre	Longitud	Peso
	<i>Pulg.</i>		<i>(m.)</i>	<i>Kg./m.</i>
8EP12	8 x 2 3/4	12	8	7.96
8EP14	8 x 2 3/4	14	6 y 8	5.70
8EP16	8 x 2 3/4	16	8	4.50
9EP10	9 x 2 3/4	10	9	10.60
9EP16	9 x 2 3/4	16	9	4.90
10EP12	10 x 2 3/4	12	10	9.06
10EP14	10 x 2 3/4	14	10	6.49
10EP16	10 x 2 3/4	16	10	5.20
12EP10	12 x 3 1/2	10	12	13.60
12EP12	12 x 3 1/2	12	12	10.99
12EP14	12 x 3 1/2	14	12	7.87
14EP10	14 x 3 1/2	10	14	15.00
14EP12	14 x 3 1/2	12	14	12.10
14EP14	14 x 3 1/2	14	14	8.70



TIGRE-PTR

www.laminaseltigre.com 800-35-84473 81-83-14-16-10



TIGRE-PTR RECTANGULAR

Medidas		Calibre	Espesor		Longitud <i>m.</i>	Peso <i>kg./m.</i>
<i>Pulg.</i>	<i>mm.</i>		<i>Pulg.</i>	<i>mm.</i>		
2 x 1	50.8 x 25.4	14	0.075	1.90	6.00	2.24
		11	0.120	3.04	6.10	3.16
2 1/2 x 1 1/2	63.5 x 38.1	14	0.075	1.90	6.00	3.03
		12	0.105	2.67	6.00	4.16
3 x 1 1/2	76.2 x 38.1	14	0.075	1.90	6.00	3.43
3 x 2	76.2 x 50.8	14	0.075	1.90	6.00	3.82
		11	0.120	3.04	6.00	5.59
		10	0.135	3.42	6.00	6.22
		9	0.150	3.80	6.10	6.75
		3/16"	0.188	4.76	6.10	8.33
		1/4"	0.250	6.35	6.10	10.57
4 x 1 1/2	101.6 x 38.1	14	0.075	1.90	6.00	4.22
4 x 2	101.6 x 50.8	14	0.075	1.90	6.00	4.61
		11	0.120	3.04	6.00	6.81
		9	0.150	3.80	6.00	8.26
		3/16"	0.188	4.76	6.10	10.24
		1/4"	0.250	6.35	6.10	13.10
4 x 3	101.6 x 76.2	14	0.075	1.90	6.00	5.40
		11	0.120	3.04	6.00	8.02
		9	0.150	3.80	6.00	9.75
		3/16"	0.188	4.76	6.10	12.14
		1/4"	0.250	6.35	6.10	15.63
5 x 3	127 x 76.2	14	0.075	1.90	6.10	5.87
		11	0.120	3.04	6.10	9.60
		10	0.135	3.42	6.10	10.24
		9	0.150	3.80	6.10	11.24
		3/16"	0.188	4.76	6.10	14.00
		1/4 "	0.250	6.35	6.10	18.15
6 x 2	152.4 x 50.8	14	0.075	1.90	6.10	5.87
		11	0.120	3.04	6.10	9.60
		10	0.135	3.42	6.10	10.24
		9	0.150	3.80	6.10	11.24

TIGRE-PTR

www.laminaseltigre.com 800-35-84473 81-83-14-16-10



Medidas		Calibre	Espesor		Longitud	Peso
Pulg.	mm.		Pulg.	mm.		
6 x 2	152.4 x 50.8	3/16"	0.188	4.76	6.10	14.00
		1/4"	0.250	6.35	6.10	18.15
6 x 3	152.4 x 76.2	14	0.075	1.90	6.10	6.63
		11	0.120	3.04	6.10	10.24
		10	0.135	3.42	6.10	11.52
		9	0.150	3.80	6.10	13.02
		3/16"	0.188	4.76	6.10	15.90
		1/4"	0.250	6.35	6.10	20.67
		14	0.075	1.90	6.10	7.39
6x4	152.4 x 101.6	11	0.120	3.04	6.00	11.66
		10	0.135	3.42	6.10	13.18
		9	0.150	3.80	6.10	14.22
		8	0.164	4.18	6.10	16.13
		3/16"	0.188	4.76	6.10	17.85
		1/4"	0.250	6.35	6.10	23.22
		3/8"	0.375	9.5	12.2	33.27

TIGRE-PTR CUADRADO

Medidas		Calibre	Espesor		Longitud	Peso
Pulg.	mm.		Pulg.	mm.		
3/4 x 3/4	19.05 x 19.05	14	0.075	1.90	6	1.06
1 x 1	25.4 x 25.4	14	0.075	1.90	6	1.46
		13	0.090	2.28	6	1.66
		12	0.105	2.67	6	1.95
		11	0.120	3.04	6	1.97
		10	0.135	3.42	6	2.13
1 1/4 x 1 1/4	31.75 x 31.75	14	0.075	1.90	6	1.85
		12	0.105	2.67	6	1.95
		11	0.120	3.04	6	1.97
1 1/2 x 1 1/2	38.1 x 38.1	10	0.135	3.42	6	3.20
		14	0.075	1.90	6	2.24
		12	0.105	2.67	6	3.07
		11	0.120	3.04	6	3.16
1 3/4 x 1 3/4	44.45 x 44.45	10	0.135	3.42	6	3.49
		14	0.075	1.90	6	2.64

TIGRE-PTR

www.laminaseltigre.com 800-35-84473 81-83-14-16-10



Medidas		Calibre	Espesor		Longitud m.	Peso kg./m.
Pulg.	mm.		Pulg.	mm.		
2 x 2	50.8 x 50.8	14	0.075	1.90	6	3.03
		12	0.105	2.67	6	4.17
		11	0.120	3.04	6	4.38
		10	0.135	3.42	6	4.86
		3/16"	0.188	4.76	6	6.43
		1/4"	0.250	6.35	6	8.04
2 1/4 x 2 1/4	57.15 x 57.15	14	0.075	1.90	6	3.15
2 1/2 x 2 1/2	63.5 x 63.5	16	0.059	1.49	6	2.95
		14	0.075	1.90	6	3.82
		13	0.089	2.26	6	4.38
		12	0.105	2.67	6	5.27
		11	0.120	3.04	6	5.59
		10	0.135	3.42	6	6.22
		9	0.150	3.80	6	6.76
		3/16"	0.188	4.76	6.1	8.33
		1/4"	0.250	6.35	6.1	10.57
		3 x 3	76.2 x 76.2	14	0.075	1.90
12	0.105			2.67	6.1	6.38
11	0.120			3.04	6	6.80
10	0.135			3.42	6	7.54
9	0.150			3.80	6	8.26
3/16"	0.188			4.76	6.1	10.24
1/4"	0.250			6.35	6.1	13.10
3 1/2 x 3 1/2	88.9 x 88.9	14	0.075	1.90	6	5.11
		11	0.120	3.04	6	8.02
		9	0.150	3.80	6	9.75
		3/16"	0.188	4.76	6.1	12.14
		1/4"	0.250	6.35	6.1	18.16
4 x 4	101.6 x 101.6	14	0.075	1.90	6	6.19
		11	0.120	3.04	6	9.23
		10	0.135	3.42	6	10.24
		9	0.150	3.80	6	11.25
		3/16"	0.188	4.76	6.1	14.04
		1/4"	0.250	6.35	6.10	18.16
4 1/2 x 4 1/2	114.3 x 114.3	11	0.120	3.04	6	10.24
		3/16"	0.188	4.76	6.1	15.90
		1/4"	0.250	6.35	6.1	20.67

TIGRE-PTR

www.laminaseltigre.com 800-35-84473 81-83-14-16-10



Medidas		Calibre	Espesor		Longitud	Peso
<i>Pulg.</i>	<i>mm.</i>		<i>Pulg.</i>	<i>mm.</i>		
5 x 5	127 x 127	11	0.120	3.04	6	12.13
		9	0.150	3.80	6	14.22
		3/16"	0.188	4.76	6.1	17.85
		1/4"	0.250	6.35	6.1	23.22
		5/16"	0.312	7.92	12.20	28.39
		3/8"	0.375	9.53	12.20	33.29



TIGRE-HSS

www.laminaseltigre.com 800-35-84473 81-83-14-16-10



TABLA DE PESOS

Dimensión exterior		Espesor		Peso
<i>Pulg.</i>	<i>mm.</i>	<i>Pulg.</i>	<i>mm.</i>	<i>kg./m.</i>
6 x 6	152.4 x 152.4	3/16	4.76	21.62
		1/4	6.35	28.31
		5/16	7.94	34.73
		3/8	9.53	40.90
		1/2	12.70	52.44
8 x 4	203.2 x 101.6	3/16	4.76	21.62
		1/4	6.35	28.31
		5/16	7.94	34.73
		3/8	9.53	40.90
		1/2	12.70	52.44
8 x 6	203.2 x 152.4	3/16	4.76	25.42
		1/4	6.35	33.37
		5/16	7.94	41.07
		3/8	9.53	48.48
		1/2	12.70	62.58
8 x 8	203.2 x 203.2	3/16	4.76	29.21
		1/4	6.35	38.42
		5/16	7.94	47.38
		3/8	9.53	56.09
		1/2	12.70	72.70
		5/8	15.88	88.28
10 x 4	254 x 101.6	3/16	4.76	25.42
		1/4	6.35	33.36
		5/16	7.94	41.06
		3/8	9.53	48.48
		1/2	12.70	62.58
10 x 6	254 x 152.4	3/16	4.76	29.21
		1/4	6.35	38.42
		5/16	7.94	47.38
		3/8	9.53	56.09
		1/2	12.70	72.70
10 x 8	254 x 203.2	3/16	4.76	33.01
		1/4	6.35	43.50
		5/16	7.94	53.72
		3/8	9.53	63.68

TIGRE-HSS

www.laminaseltigre.com 800-35-84473 81-83-14-16-10



Dimensión exterior		Espesor		Peso
<i>Pulg.</i>	<i>mm.</i>	<i>Pulg.</i>	<i>mm.</i>	<i>kg./m.</i>
10 x 8	254 x 203.2	1/2	12.70	82.83
10 x 10	254 x 254	3/16	4.76	36.80
		1/4	6.35	48.56
		5/16	7.94	60.05
		3/8	9.53	71.28
		1/2	12.70	92.95
		5/8	15.88	113.59
12 x 4	304.8 x 101.6	3/16	4.76	29.21
		1/4	6.35	38.42
		5/16	7.94	47.38
		3/8	9.53	56.09
12 x 6	304.8 x 152.4	3/16	4.76	33.01
		1/4	6.35	43.50
		5/16	7.94	53.72
		3/8	9.53	63.68
		1/2	12.70	82.83
12 x 8	304.8 x 203.2	3/16	4.76	36.80
		1/4	6.35	48.56
		5/16	7.94	60.05
		3/8	9.53	71.28
		1/2	12.70	92.95
		5/8	15.88	113.59
12 x 12	304.8 x 304.8	1/4	6.35	58.68
		5/16	7.94	72.71
		3/8	9.53	86.46
		1/2	12.70	113.20
		5/8	15.88	138.90
14 x 6	355.6 x 152.4	5/16	7.94	60.05
		3/8	9.53	71.28
14 x 14	355.6 x 355.6	5/16	7.94	85.36
		3/8	9.53	101.66

TIGRE-HSS

www.laminaseltigre.com 800-35-84473 81-83-14-16-10



Dimensión exterior		Espesor		Peso
<i>Pulg.</i>	<i>mm.</i>	<i>Pulg.</i>	<i>mm.</i>	<i>kg./m.</i>
14 x 14	355.6 x 355.6	1/2	12.70	133.46
		5/8	15.88	164.23
16 X 8	406.4 X 203.2	3/16	4.76	44.41
		5/16	7.94	72.71
		1/2	12.70	113.20
16 x 12	406.4 x 304.8	5/16	7.94	85.36
		3/8	9.53	101.66
		1/2	12.70	133.46
16 x 16	406.4 x 406.4	5/16	7.94	98.03
		3/8	9.53	116.85
		1/2	12.70	153.50
		5/8	15.88	189.55



TIGRE-PLACA

www.laminaseltigre.com 800-35-84473 81-83-14-16-10



Espesor			Peso		Dimensión					
Pulg.	Milésimas	mm.	kg./m.2	kg./pie2	4'x10'	5'x10'	5'x20'	6'x10'	6'x20'	8'x20'
3/16"	188	4.8	37.4	3.5	138.9	173.7	347.3	208.4	416.8	555.7
1/4"	250	6.4	49.9	4.6	185.2	231.6	463.1	277.9	555.7	741.0
5/16"	313	7.9	62.3	5.8	231.6	289.4	578.9	347.3	694.7	926.2
3/8"	375	9.5	74.8	7.0	277.9	347.3	694.7	416.8	833.6	1111.4
7/16"	438	11.1	87.2	8.1	324.2	405.2	810.4	486.3	972.5	1296.7
1/2"	500	12.7	99.7	9.3	370.5	463.1	926.2	555.7	1111.4	1481.9
5/8"	625	15.9	124.6	11.6	463.1	578.9	1157.8	694.7	1389.3	1852.4
3/4"	750	19.1	149.5	13.9	555.7	694.7	1389.3	833.6	1667.2	2222.9
7/8"	875	22.2	174.5	16.2	648.3	810.4	1620.9	972.5	1945.0	2593.4
1"	1000	25.4	199.4	18.5	741.0	926.2	1852.4	1111.4	2222.9	2963.8
1 1/4"	1250	31.8	249.2	23.2	926.2	1157.8	2315.5	1389.3	2778.6	3704.8
1 1/2"	1500	38.1	299.1	27.8	1111.4	1389.3	2778.6	1667.2	3334.3	4445.8
1 3/4"	1750	44.5	348.9	32.4	1296.7	1620.9	3241.7	1945.0	3890.0	5186.7
2"	2000	50.8	398.8	37.1	1481.9	1852.4	3704.8	2222.9	4445.8	5927.7
2 1/2"	2500	63.5	498.5	46.3	1852.4	2315.5	4631.0	2778.6	5557.2	7409.6
3"	3000	76.2	598.2	55.6	2222.9	2778.6	5557.2	3334.3	6668.6	8891.5
3 1/2"	3500	88.9	697.9	64.8	2593.4	3241.7	6483.4	3890.0	7780.1	10373.4
4"	4000	101.6	797.6	74.1	2963.8	3704.8	7409.6	4445.8	8891.5	11855.3
4 1/2"	4500	114.3	897.3	83.4	3334.3	4167.9	8335.8	5001.5	10002.9	13337.3
5"	5000	127.0	997.0	92.6	3704.8	4631.0	9262.0	5557.2	11114.4	14819.2
6"	6000	152.4	1196.3	111.1	4445.8	5557.2	11114.4	6668.6	13337.3	17783.0

TIGRE-LÁMINA ROLADA EN CALIENTE

Calibre	Espesor		Peso		Peso Teórico
	Pulg.	mm.	kg./pie ²	kg./m. ²	4' x 10'
4	0.224	5.69	4.15	44.67	165.99
6	0.194	4.94	3.60	38.78	144.11
7	0.179	4.55	3.32	35.72	132.73
8	0.164	4.18	3.05	32.81	121.94
9	0.150	3.80	2.77	29.83	110.85
10	0.135	3.42	2.49	26.85	99.77
11	0.120	3.04	2.22	23.86	88.68
12	0.105	2.66	1.94	20.88	77.60
13	0.090	2.28	1.66	17.90	66.51
14	0.075	1.90	1.39	14.92	55.43
16	0.060	1.52	1.11	11.93	44.34

TIGRE-LÁMINA ROLADA EN FRÍO

Calibre	Espesor		Peso		Peso teórico por pieza
	Pulg.	mm.	kg./pie ²	kg./m. ²	4' x 10'
16	0.0598	1.52	1.11	11.93	44.34
18	0.0478	1.21	0.88	9.50	35.30
20	0.0359	0.91	0.66	7.14	26.55
22	0.0299	0.76	0.55	5.97	22.17
24	0.0239	0.61	0.44	4.79	17.80
26	0.0179	0.45	0.33	3.53	13.13
28	0.0149	0.38	0.28	2.98	-
30	0.0120	0.30	0.22	2.36	-

TIGRE-ANTIDERRAPANTE

www.laminaseltigre.com 800-35-84473 81-83-14-16-10



TABLA DE PESOS

Calibre	Espesor		Peso		Peso teórico por pieza 4' x 10'
	Pulg.	mm.	kg./pie2	kg./m.2	
1/2	0.5	12.7	9.74	104.8	389.55
3/8	0.375	9.53	7.42	79.74	296.65
5/16	0.313	7.94	6.26	67.31	250.38
1/4	0.25	6.35	5.1	54.87	204.12
3/16	0.188	4.76	3.95	42.43	157.85
1/8	0.125	3.18	2.79	30	111.58
12	0.105	2.66	2.38	25.61	95.25
14	0.075	1.9	1.7	18.29	68.04



TIGRE-ÁNGULO

www.laminaseltigre.com 800-35-84473 81-83-14-16-10



TABLA DE PESOS

Pulgadas		Milímetros		Peso
Espesor (k)	Ancho (bf)	Espesor (k)	Ancho (bf)	kg./m.
cal.12 (.109") x	1	2.77 x	25.4	1.06
	1 1/4		31.75	1.32
	1 1/2		38.1	1.61
1/8 x	3/4	3.18 x	19.05	0.88
	1		25.4	1.19
	1 1/4		31.75	1.5
	1 1/2		38.1	1.83
5/32 x	2	3.96 x	50.8	2.46
	1 1/2		38	2.26
3/16 x	2	4.76 x	50.8	3.04
	1		25.4	1.73
	1 1/4		31.75	2.2
	1 1/2		38.1	2.68
	2		50.8	3.63
	2 1/2		63.5	4.57
1/4 x	3	6.35 x	76.2	5.52
	1		25.4	2.22
	1 1/4		31.75	2.86
	1 1/2		38.1	3.48
	2		50.8	4.75
	2 1/2		63.5	6.1
	3		76.2	7.29
	3 1/2		88.9	8.63
5/16 x	4	7.94 x	101.6	9.82
	2		50.8	5.83
	2 1/2		63.5	7.44
	3		76.2	9.08
	3 1/2		88.9	10.71
	4		101.6	12.2
	5		127	15.3

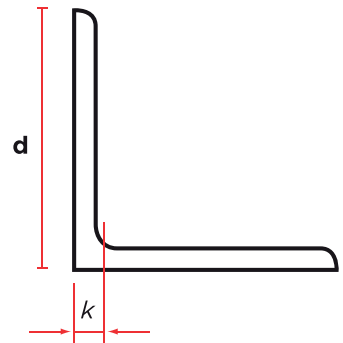

TIGRE-ÁNGULO

www.laminaseltigre.com 800-35-84473 81-83-14-16-10



Pulgadas		Milímetros		Peso
<i>Espesor (k)</i>	<i>Ancho (bf)</i>	<i>Espesor (k)</i>	<i>Ancho (bf)</i>	<i>kg./m.</i>
3/8 x	2	9.53 x	50.8	6.99
	2 1/2		63.5	8.78
	3		76.2	10.71
	4		101.6	14.58
	5		127	18.3
	6		152.4	22.17
7/16x	4	11.1x	102	16.8
	5		127	21.3
	6		152	25.6
1/2 x	3	12.70 x	76.2	13.99
	4		101.6	19.05
	5		127	24.11
	6		152.4	29.17
	8		203	39.3
5/8 x	4	15.88 x	101.6	23.36
	6		152.4	36.01
	8		203.2	48.66
3/4 x	5	19.05 x	127	35.12
	6		152.4	42.71
	8		203.2	57.89
7/8 X	8	22.23	203	66.97
1	6	25.4	152.4	55.66
	8	25.4	203	75.9
1 1/8 X	8	28.56	203	84.68



TIGRE-SOLERA

www.laminaseltigre.com 800-35-84473 81-83-14-16-10



TABLA DE PESOS

Pulgadas		Milímetros		Peso	Pulgadas		Milímetros		Peso
Espesor	Ancho	Espesor	Ancho	kg./m.	Espesor	Ancho	Espesor	Ancho	kg./m.
1/8	1/2	3.2	12.7	0.31	3/8	1 1/2	9.5	38.1	2.84
	3/4		19.1	0.47		2		50.8	3.79
	1		25.4	0.63		2 1/2		63.5	4.74
	1 1/4		31.7	0.79		3		76.2	5.69
	1 1/2		38.1	0.95		4		101.6	7.59
	2		50.8	1.26		5		127	9.49
3/16	1/2	4.8	12.7	0.47	6	152.4	11.38		
	3/4		19.1	0.71	8	203.2	15.19		
	1		25.4	0.94	10	254	18.99		
	1 1/4		31.7	1.18	12	304.8	22.78		
	1 1/2		38.1	1.42	1 1/2	38.1	3.81		
	2		50.8	1.90		2	50.8	5.06	
1/4	2 1/2	6.3	63.5	2.37	2 1/2	63.5	6.32		
	1/2		12.7	0.63	3	76.2	7.59		
	3/4		19.1	0.95	4	101.6	10.12		
	1		25.4	1.26	5	127	12.65		
	1 1/4		31.7	1.58	6	152.4	15.18		
	1 1/2		38.1	1.90	8	203.2	20.25		
	2		50.8	2.53	10	254	25.31		
	2 1/2		63.5	3.17	12	304.8	30.39		
	3		76.2	3.79	5/8	4	101.6	12.65	
	4		101.6	5.06		5	127	15.81	
	5		127	6.32		6	152.4	18.97	
	6		152.4	7.59		8	203.2	25.31	
	8		203.2	10.12		9	228.6	28.47	
	10		254	12.65		10	254	31.65	
5/16	12	7.9	304.8	15.18	12	304.8	37.99		
	1		25.4	1.58	3/4	2 1/2	63.5	9.49	
	1 1/2		38.1	2.37		3	76.2	11.39	
	2		50.8	3.16		4	101.6	15.18	
	2 1/2		63.5	3.95		5	127	18.98	
	3		76.2	4.79		6	152.4	22.77	
	4		101.6	6.32					
	5		127	7.90					
6	152.4	9.49							
3/8	1	9.5	25.4	1.90					
	1 1/4		31.7	2.37					

TIGRE-SOLERA

www.laminaseltigre.com 800-35-84473 81-83-14-16-10



Pulgadas		Milímetros		Peso
Espesor	Ancho	Espesor	Ancho	kg./m.
3/4	8	19.05	203.2	30.38
	9		228.6	34.16
	10		254	37.98
	12		304.8	45.57
1	2	25.4	50.8	10.12
	3		76.2	15.18
	4		101.6	20.24
	5		127	25.31
	6		152.4	30.37
	8		203.2	40.49
	10		254	50.64
	12		304.8	60.76



TIGRE-REDONDO

www.laminaseltigre.com 800-35-84473 81-83-14-16-10



TABLA DE PESOS

Medidas			Peso
			Redondo
<i>pulg.</i>	<i>milésimas</i>	<i>mm.</i>	<i>kg./m.</i>
12 mm.	0.472	12.00	-
3/8	0.375	9.53	0.56
1/2	0.500	12.70	0.99
5/8	0.625	15.88	1.55
3/4	0.750	19.05	2.24
7/8	0.875	22.23	3.04
1	1.000	25.40	3.97
1 1/8	1.125	28.58	5.03
1 1/4	1.250	31.75	6.21
1 3/8	1.375	34.93	7.51
1 1/2	1.500	38.10	8.94
1 3/4	1.750	44.45	12.17
2	2.000	50.80	15.90
2 1/2	2.500	63.50	24.84
3	3.000	76.20	35.76



TIGRE-CANAL

www.laminasetigre.com 800-35-84473 81-83-14-16-10



TABLA DE PESOS

Peralte		Peso		Patin				Alma	
d				Ancho (bf)		Espesor (tf)		Espesor (tw)	
pulg.	mm.	kg./m.	lb./pie	pulg.	mm.	pulg.	mm.	pulg.	mm.
3	76.2	5.21	3.5	1.372	34.85	0.273	6.93	0.132	3.35
		6.10	4.1	1.410	35.81	0.273	6.93	0.170	4.32
4	101.6	6.70	4.5	1.584	40.23	0.296	7.52	0.125	3.18
		8.04	5.4	1.584	40.23	0.296	7.52	0.184	4.67
5	127.0	9.97	6.7	1.750	44.45	0.320	8.13	0.190	4.83
		13.5	9	1.88	47.9	0.32	8.13	0.326	8.3
6	152.4	12.2	8.2	1.920	48.77	0.343	8.71	0.200	5.08
		15.63	10.5	2.034	51.66	0.343	8.71	0.314	7.98
		19.35	13.0	2.157	54.79	0.343	8.71	0.437	11.10
8	203.2	17.11	11.5	2.260	57.40	0.390	9.91	0.220	5.59
		20.46	13.75	2.343	59.51	0.390	9.91	0.303	7.70
		27.90	18.75	2.527	64.19	0.390	9.91	0.487	12.37
10	254.0	22.77	15.3	2.600	66.04	0.436	11.07	0.240	6.10
		29.76	20	2.739	69.57	0.436	11.07	0.379	9.63
		37.2	25	2.886	73.30	0.436	11.07	0.526	13.36
		44.64	30	3.033	77.04	0.436	11.07	0.673	17.09
12	304.8	30.80	20.7	2.942	74.73	0.501	12.73	0.282	7.16
		37.2	25	3.047	77.39	0.501	12.73	0.387	9.83
		44.64	30	3.170	80.52	0.501	12.73	0.510	12.95
15	381.0	50.45	33.9	3.400	86.36	0.650	16.51	0.400	10.16
		59.53	40	3.520	89.41	0.650	16.51	0.520	13.21

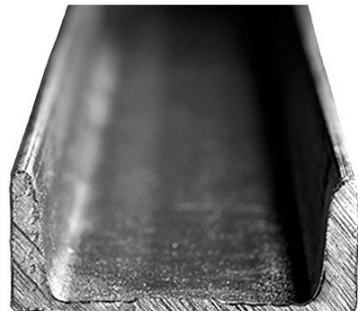
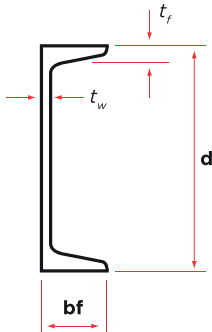

TIGRE-VIGA

www.laminasetigre.com 800-35-84473 81-83-14-16-10



"TIGRE-VIGA IPS"

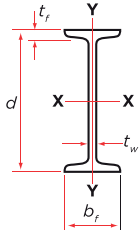

Peralte d	Peso				Patin				Alma	
					Ancho (bf)		Espesor (tf)		Espesor (tw)	
pulg.	mm.	kg./m.	lb./pie	pulg.	mm.	pulg.	mm.	pulg.	mm.	
3	76.2	8.48	5.70	2.33	59.18	0.26	6.6	0.17	4.3	
4	101.6	11.46	7.70	2.66	67.64	0.29	7.4	0.19	4.9	
5	127.0	14.88	10.00	3.00	76.30	0.33	8.3	0.21	5.4	
6	152.4	18.60	12.50	3.33	84.63	0.36	9.1	0.23	5.9	
8	200	26.20	17.61	3.54	90	0.45	11.30	0.30	7.5	

"TIGRE-VIGA IPR"

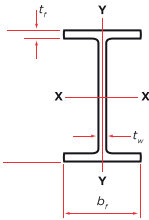

Nominal		Peso		Peralte		Patin				Alma	
pulg. (d x bf)	mm. (d x bf)			pulg.	mm.	Ancho (bf)		Espesor (tf)		Espesor (tw)	
		kg./m.	lb./pie	pulg.	mm.	pulg.	mm.	pulg.	mm.	pulg.	mm.
4 x 4	101.6 x 101.6	12.6	8.5	4.16	106	4.06	103	0.35	8.8	0.28	7.11
		12.6	8.5	5.83	148	3.94	100	0.20	5.0	0.17	4.3
6 x 4	152.4 x 101.6	13.4	9	5.90	150	3.94	100	0.22	5.5	0.17	4.3
		17.9	12	6.03	153	4.00	102	0.28	7.1	0.23	5.8
		23.8	16	6.28	160	4.03	102	0.41	10.3	0.26	6.6
6 x 6	152.4 x 152.4	22.3	15	5.99	152	5.99	152	0.26	6.6	0.23	5.8
		29.8	20	6.20	157	6.02	153	0.37	9.3	0.26	6.6
8 x 4	203.2 x 101.6	37.2	25	6.38	162	6.08	154	0.46	11.6	0.32	8.1
		14.9	10	7.89	200	3.94	100	0.21	5.2	0.17	4.3
8 x 5-1/4	203.2 x 133.4	19.3	13	7.99	203	4.00	102	0.26	6.5	0.23	5.8
		22.3	15	8.11	206	4.02	102	0.32	8.0	0.25	6.2
8 x 6-1/2	203.2 x 165.1	26.8	18	8.14	207	5.25	133	0.33	8.4	0.23	5.8
		31.2	21	8.28	210	5.27	134	0.40	10.2	0.25	6.4
8 x 8	203.2 x 203.2	35.7	24	7.93	201	6.50	165	0.40	10.2	0.25	6.2
		41.7	28	8.06	205	6.54	166	0.47	11.8	0.29	7.2
		46.1	31	8.00	203	8.00	203	0.44	11.0	0.29	7.2
		52.1	35	8.12	206	8.02	204	0.50	12.6	0.31	7.9
		59.5	40	8.25	210	8.07	205	0.56	14.2	0.36	9.1
10 x 4	254 x 101.6	71.4	48	8.50	216	8.11	206	0.69	17.4	0.40	10.2
		86.3	58	8.75	222	8.22	209	0.81	20.6	0.51	13.0
		17.9	12	9.87	251	3.96	101	0.21	5.3	0.19	4.8
		22.3	15	9.99	254	4.00	102	0.27	6.9	0.23	5.8
10 x 5-3/4	254 x 146	25.3	17	10.11	257	4.01	102	0.33	8.4	0.24	6.1
		28.3	19	10.24	260	4.02	102	0.40	10.0	0.25	6.4
		32.7	22	10.17	258	5.75	146	0.36	9.1	0.24	6.1
10 x 8	254 x 203.2	38.7	26	10.33	262	5.77	147	0.44	11.2	0.26	6.6
		44.6	30	10.47	266	5.81	148	0.51	13.0	0.30	7.6
		49.1	33	9.73	247	7.96	202	0.44	11.0	0.29	7.4
10 x 8	254 x 203.2	58	39	9.92	252	7.99	203	0.53	13.5	0.32	8.0
		67	45	10.1	257	8.02	204	0.62	15.7	0.35	8.9

TIGRE-VIGA

www.laminasetigre.com 800-35-84473 81-83-14-16-10



Nominal		Peso		Peralte		Patin				Alma	
				d		Ancho (bf)		Espesor (tf)		Espesor (tw)	
pulg. (d x bf)	mm. (d x bf)	kg./m.	lb./pie	pulg.	mm.	pulg.	mm.	pulg.	mm.	pulg.	mm.
10 x 10	254 x 254	72.9	49	10.0	253	10.0	254	0.56	14.2	0.34	8.6
		80.4	54	10.09	256	10.0	255	0.62	15.6	0.37	9.4
		89.3	60	10.22	260	10.1	256	0.68	17.3	0.42	10.7
		101.1	68	10.40	264	10.1	257	0.77	19.6	0.47	11.9
		114.6	77	10.60	269	10.2	259	0.87	22.1	0.53	13.5
		130.9	88	10.84	275	10.3	261	0.99	25.1	0.61	15.4
		148.8	100	11.10	282	10.3	263	1.12	28.4	0.68	17.3
		166.7	112	11.36	289	10.4	265	1.25	31.8	0.76	19.2
12 x 4	304.8 x 101.6	20.8	14	11.91	303	3.97	101	0.23	5.7	0.20	5.1
		23.8	16	11.99	305	3.99	101	0.27	6.7	0.22	5.6
		28.3	19	12.16	309	4.01	102	0.35	8.9	0.24	6.0
		32.7	22	12.31	313	4.03	102	0.43	10.8	0.26	6.6
12 x 6-1/2	304.8 x 165.1	38.7	26	12.22	310	6.49	165	0.38	9.7	0.23	5.8
		44.6	30	12.34	313	6.52	166	0.44	11.2	0.26	6.6
		52.1	35	12.50	318	6.56	167	0.52	13.2	0.30	7.6
12 x 8	304.8 x 203.2	59.5	40	11.94	303	8.01	203	0.52	13.1	0.30	7.5
		67.0	45	12.06	306	8.05	204	0.58	14.6	0.34	8.5
		74.4	50	12.19	310	8.08	205	0.64	16.3	0.37	9.4
12 x 10	304.8 x 254	78.9	53	12.06	306	10	254	0.58	14.6	0.35	8.8
		86.3	58	12.19	310	10.01	254	0.64	16.3	0.36	9.1
12 x 12	304.8 x 304.8	96.7	65	12.12	308	12	305	0.61	15.4	0.39	9.9
		107.1	72	12.25	311	12.04	306	0.67	17.0	0.43	10.9
		117.6	79	12.38	314	12.08	307	0.74	18.7	0.47	11.9
		129.45	87	12.53	318	12.13	308	0.810	20.6	0.52	13.1
		142.9	96	12.71	323	12.16	309	0.90	22.9	0.55	14.0
		157.72	106	12.89	327	12.22	310	0.990	25.1	0.61	15.5
		202.36	136	13.41	341	12.40	315	1.250	31.8	0.79	20.1
		226.2	152	13.710	348	12.48	317	1.400	35.6	0.870	22.1
		253.0	170	14.03	356	12.57	319	1.56	39.6	0.96	24.4
		282.7	190	14.38	365	12.67	322	1.74	44.1	1.06	26.9
		312.5	210	14.71	374	12.79	325	1.90	48.3	1.18	30
		342.3	230	15.05	382	12.90	328	2.07	52.6	1.29	32.6
		14 x 5	355.6 x 127	32.7	22	13.74	349	5.00	127	0.34	8.5
38.7	26			13.91	353	5.03	128	0.42	10.7	0.26	6.5
14 x 6-3/4	355.6 x 171.4	44.6	30	13.84	352	6.73	171	0.39	9.8	0.27	6.9
		50.6	34	13.98	355	6.75	171	0.46	11.6	0.29	7.2
		56.5	38	14.10	358	6.77	172	0.52	13.1	0.31	7.9
14 x 8	355.6 x 203.2	64.0	43	13.66	347	8.00	203	0.53	13.5	0.31	7.7
		71.4	48	13.79	350	8.03	204	0.60	15.1	0.34	8.6
		78.9	53	13.92	354	8.06	205	0.66	16.8	0.37	9.4

TIGRE-VIGA

www.laminaseltigre.com 800-35-84473 81-83-14-16-10



Nominal		Peso		Peralte		Patin				Alma	
				d		Ancho (bf)		Espesor (tf)		Espesor (tw)	
pulg.	mm.	kg./m.	lb./pie	pulg.	mm.	pulg.	mm.	pulg.	mm.	pulg.	mm.
14 x 10	355.6 x 254	90.8	61	13.89	353	10	254	0.65	16.4	0.38	9.5
		101.2	6	14.04	357	10.04	255	0.72	18.3	0.42	10.5
		110.1	7	14.17	360	10.07	256	0.79	19.9	0.45	11.4
		122.0	82	14.31	363	10.13	257	0.855	21.7	0.51	13.0
14 x 14-1/2	355.6 x 368.3	133.9	90	14.02	356	14.52	369	0.71	18.0	0.44	11.2
		147.3	99	14.16	360	14.57	370	0.78	19.8	0.49	12.3
		162.2	109	14.32	364	14.61	371	0.86	21.8	0.53	13.3
		178.6	120	14.48	368	14.67	373	0.94	23.9	0.59	15.0
18 x 11	457.2 x 279.4	196.4	132	14.66	372	14.73	374	1.03	26.2	0.65	16.4
		421.2	283	21.85	554	11.89	302	2.5	63.5	1.4	35.6
21 x 6-1/2	533.4 x 165.1	462.8	311	22.32	567	12.01	305	2.74	69.6	1.52	38.6
		65.5	44	20.66	25	6.50	165	0.45	11.4	0.35	8.9
		74.4	50	20.83	529	6.53	166	0.54	13.6	0.38	9.7
21 x 8-1/4	533.4 x 209.5	84.8	57	21.06	535	6.56	166	0.65	16.5	0.41	10.3
		92.3	62	20.99	533	8.24	209	0.62	15.6	0.40	10.2
		101.2	68	21.13	537	8.27	210	0.69	17.4	0.43	10.9
		108.6	73	21.24	539	8.30	211	0.74	18.8	0.46	11.6
21 x 12-1/4	533.4 x 311.15	123.5	83	21.43	544	8.36	212	0.84	21.2	0.52	13.1
		138.4	93	21.62	549	8.42	214	0.93	23.6	0.58	14.7
		150.3	101	21.36	543	12.29	312	0.80	20.3	0.50	12.7
21 x 12-1/2	533.4 x 317.5	165.2	111	21.51	546	12.34	313	0.88	22.2	0.55	14.0
		181.5	122	21.68	551	12.39	315	0.96	24.4	0.60	15.2
24 x 7	609.6 x 177.8	218.0	47	22.06	60	12.51	318	1.15	29.2	0.72	18.3
		81.8	55	23.57	599	7.01	178	0.51	12.8	0.40	10.0
14 x 16	355.6 x 406.4	92.3	62	23.74	603	7.04	179	0.59	15.0	0.43	10.9
		215.8	145	14.78	375	15.50	394	1.09	27.7	0.68	17.3
		236.6	159	14.98	380	15.57	395	1.19	30.2	0.75	18.9
		261.9	176	15.22	387	15.65	398	1.31	33.3	0.83	21.1
		287.2	193	15.48	393	15.71	399	1.44	36.6	0.89	22.6
		314.0	211	15.72	399	15.80	401	1.56	39.6	0.98	24.9
16 x 5-1/2	406.4 x 139.7	346.7	233	16.04	407	15.89	404	1.72	43.7	1.07	27.2
		382.4	257	16.38	416	16.00	406	1.89	48.0	1.18	29.8
16 x 5-1/2	406.4 x 139.7	38.7	26	15.69	399	5.50	140	0.35	8.8	0.25	6.4
		46.1	31	15.88	403	5.53	140	0.44	11.2	0.28	7.0

TIGRE-VIGA

www.laminaseltigre.com 800-35-84473 81-83-14-16-10



Nominal		Peso		Peralte		Patin				Alma	
				d		Ancho (bf)		Espesor (tf)		Espesor (tw)	
pulg. (d x bf)	mm. (d x bf)	kg./m.	lb./pie	pulg.	mm.	pulg.	mm.	pulg.	mm.	pulg.	mm.
16 x 7	406.4 x 177.8	53.6	36	15.86	403	6.99	177	0.43	10.9	0.30	7.5
		59.5	40	16.01	407	7.00	178	0.51	12.8	0.31	7.7
		67.0	45	16.13	410	7.04	179	0.57	14.4	0.35	8.8
		74.4	50	16.26	413	7.07	180	0.63	16.0	0.38	9.7
		84.8	57	16.43	417	7.12	181	0.72	18.2	0.43	10.9
16 x 10-1/4	406.4 x 260.3	99.7	67	16.33	415	10.24	260	0.67	16.9	0.40	10.0
		114.6	77	16.52	420	10.30	261	0.76	19.3	0.46	11.6
		132.4	89	16.75	425	10.37	263	0.88	22.2	0.53	13.3
		149.0	100	16.97	431	10.43	265	0.99	25.0	0.59	14.9
18 x 6	457.2 x 152.4	52.1	35	17.70	450	6.00	152	0.43	10.8	0.30	7.6
		59.5	40	17.90	455	6.02	153	0.53	13.3	0.32	8.0
		68.4	46	18.06	459	6.06	154	0.61	15.4	0.36	9.1
18 x 7-1/2	457.2 x 190.5	74.4	50	17.99	457	7.50	190	0.57	14.5	0.36	9.0
		81.8	55	18.11	460	7.53	191	0.63	16.0	0.39	9.9
		89.3	60	18.24	463	7.56	192	0.70	17.7	0.42	10.5
		96.7	65	18.35	466	7.59	193	0.75	19.1	0.45	11.4
		105.6	71	18.47	469	7.64	194	0.81	20.6	0.50	12.6
18 x 11	457.2 x 279.4	113.1	76	18.21	463	11.04	280	0.68	17.3	0.43	10.8
		128.0	86	18.39	467	11.09	282	0.77	19.6	0.48	12.2
		144.3	97	18.59	472	11.15	283	0.87	22.1	0.54	13.6
		157.7	106	18.73	476	11.20	284	0.94	23.9	0.59	15.0
		177.1	119	18.97	482	11.27	286	1.06	26.9	0.66	16.6
		193.5	130	19.25	489	11.16	283	1.20	30.5	0.67	17.0
		213.0	143	19.49	495	11.22	285	1.32	33.5	0.73	18.5
		235.0	158	19.72	501	11.30	287	1.44	36.6	0.81	20.6
		260.4	175	20.04	509	11.38	289	1.59	40.4	0.89	22.6
		285.7	192	20.35	517	11.46	291	1.75	44.4	0.96	24.4
		314.0	211	20.67	525	11.56	293	1.91	48.5	1.06	26.9
		348.2	234	21.06	535	11.65	296	2.11	53.6	1.16	29.5
384.0	258	21.46	545	11.77	299	2.30	58.4	1.28	32.5		
21 x 6-1/2	533.4 x 165.1	65.5	44	20.66	25	6.50	165	0.45	11.4	0.35	8.9
		74.4	50	20.83	529	6.53	166	0.54	13.6	0.38	9.7
		84.8	57	21.06	535	6.56	166	0.65	16.5	0.41	10.3

TIGRE-VIGA

www.laminaseltigre.com 800-35-84473 81-83-14-16-10



Nominal		Peso		Peralte		Patin				Alma	
				d		Ancho (bf)		Espesor (tf)		Espesor (tw)	
pulg. (d x bf)	mm. (d x bf)	kg./m.	lb./pie	pulg.	mm.	pulg.	mm.	pulg.	mm.	pulg.	mm.
21 x 8-1/4	533.4 x 209.5	92.3	62	20.99	533	8.24	209	0.62	15.6	0.40	10.2
		101.2	68	21.13	537	8.27	210	0.69	17.4	0.43	10.9
		108.6	73	21.24	539	8.30	211	0.74	18.8	0.46	11.6
		123.5	83	21.43	544	8.36	212	0.84	21.2	0.52	13.1
		138.4	93	21.62	549	8.42	214	0.93	23.6	0.58	14.7
21 x 12-1/4	533.4 x 311.15	150.3	101	21.36	543	12.29	312	0.80	20.3	0.50	12.7
		165.2	111	21.51	546	12.34	313	0.88	22.2	0.55	14.0
		181.5	122	21.68	551	12.39	315	0.96	24.4	0.60	15.2
21 x 12-1/2	533.4 x 317.5	218.0	47	22.06	60	12.51	318	1.15	29.2	0.72	18.3
24 x 7	609.6 x 177.8	81.8	55	23.57	599	7.01	178	0.51	12.8	0.40	10.0
		92.3	62	23.74	603	7.04	179	0.59	15.0	0.43	10.9



TIGRE-TUBO

www.laminaseltigre.com 800-35-84473 81-83-14-16-10



TIGRE-TUBO MECÁNICA CÉDULA 30

Cédula	Diámetro nominal		Diámetro exterior		Calibre	Espesor		Peso
	Pulg.	mm.	Pulg.	mm.		Pulg.	mm.	
30	1/2	12.70	0.840	21.34	14	0.075	1.90	0.91
	3/4	19.05	1.050	26.67	14	0.075	1.90	1.16
	1	25.40	1.315	33.40	14	0.075	1.90	1.47
	1 1/4	31.75	1.660	42.16	13	0.090	2.28	2.24
	1 1/2	38.10	1.900	48.26	13	0.090	2.28	2.58
	2	50.80	2.375	60.33	12	0.105	2.66	3.77
	2 1/2	63.50	2.875	73.03	12	0.105	2.66	4.61
	3	76.20	3.500	88.90	11	0.120	3.04	6.43
	4	101.60	4.500	114.30	11	0.120	3.04	8.33
6	152.40	6.625	168.28	3/16	0.188	4.76	19.23	

TIGRE-TUBO MECÁNICA CÉDULA 40

Cédula	Diámetro nominal		Diámetro exterior		Calibre	Espesor		Peso
	Pulg.	mm.	Pulg.	mm.		Pulg.	mm.	
40	1/2	12.70	0.840	21.34	12	0.105	2.66	1.22
	3/4	19.05	1.050	26.67	12	0.105	2.66	1.57
	1	25.40	1.315	33.40	10	0.135	3.42	2.52
	1 1/4	31.75	1.660	42.16	10	0.135	3.42	3.26
	1 1/2	38.10	1.900	48.26	10	0.135	3.42	4.16
	2	50.80	2.375	60.33	10	0.135	3.42	5.29
	2 1/2	63.50	2.875	73.03	3/16"	0.188	4.77	8.62
	3	76.20	3.500	88.90	4	0.224	5.69	11.67
	4	101.60	4.500	114.30	4	0.224	5.69	15.24
	6	152.40	6.625	168.28	0.280"	0.280	7.11	28.24



TIGRE-INOXIDABLE

www.laminaseltigre.com 800-35-84473 81-83-14-16-10



TABLA DE PESOS

Espesor		Peso en Hoja en Kg.				
CAL.	PULG.	3'x 6'	3'x 8'	3'x 10'	4'x 8'	4'x 10'
1	1.0000	334.00				
3/4	0.7500	250.00				
1/2	0.5000		223.00	278.00		373.00
3/8	0.3750		167.00	208.00		279.00
5/16	0.3125					232.00
1/4	0.2500		112.00	140.00		188.00
3/16	0.1875		84.00	105.00		141.00
5/32	0.1563					117.00
10	0.1406		62.00	78.00		105.00
1/8	0.1250		56.00	70.00		95.00
12	0.1094		49.00	61.00	65.00	82.00
14	0.0781		35.00	43.00	46.00	58.00
16	0.0625		28.00	35.00	36.00	47.00
18	0.0500		23.00	28.00	30.00	37.00
20	0.0375		17.00	21.00	22.00	28.00
22	0.0313		14.00	17.00	18.00	23.00
24	0.0250		11.00	14.00		18.00
26	0.0188		8.00	10.00		14.00
28	0.0156		7.00	9.00		
30	0.0125		6.00			

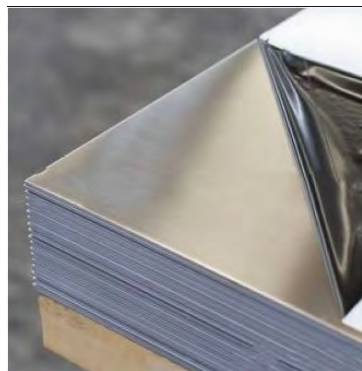

TIGRE-VARILLA

www.laminaseltigre.com 800-35-84473 81-83-14-16-10



CARACTERÍSTICAS DEL PRODUCTO

Presentación de 12 metros de longitud. Varilla de 3/8 y 1/2 se maneja en 9.15mts y 2 mts

No. Designación	Calibre		Peso		Área de la sección transversal	Perímetro
	Pulg.	mm.	Kg./m.	Lb./pie	Mm2	mm.
3	3/8	9.5	0.56	0.38	71	29.8
4	1/2	12.7	0.99	0.67	127	39.9
5	5/8	15.9	1.55	1.04	198	50
6	3/4	19.1	2.25	1.50	285	60
8	1	25.4	3.97	2.67	507	79.8
10	1 1/4	31.8	6.23	4.30	794	99.9
12	1 1/2	38.1	8.94	5.99	1140	119.7

Nota:

Número de designación corresponde al número de octavos de pulgadas equivalente al diámetro nominal de la varilla.



MULTYPANEL DE TECHO Y MURO

www.laminaseltigre.com 800-35-84473 81-83-14-16-10



DESCRIPCIÓN

Material compuesto de dos caras de lámina de acero galvanizado pintado, unidas por un núcleo de espuma rígida de poliuretano, formando un elemento tipo sandwich. Disponible para techo en espesores de 1" a 4" y para muro desde 1.5" a 4"

PANEL DE TECHO

CALIBRE	PODER C MTS	ESPESOR PULG	ACABADO
26 / 26, 26 / 28	1.000	1, 1.5, 2, 2.5, 3, 4	P

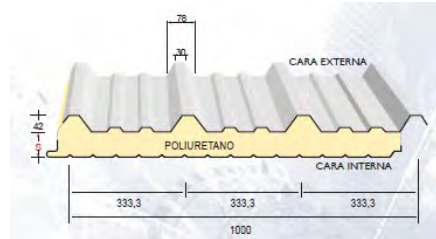

PANEL DE MURO

CALIBRE	PODER C MTS	ESPESOR PULG	ACABADO
26 / 26	1.067	2, 2.5, 3, 4, 5, 6	P

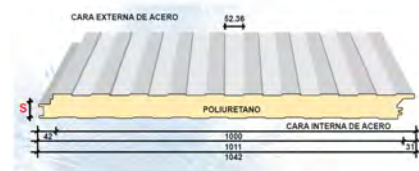

COLCHONETA DE FIBRA DE VIDRIO

www.laminasetigre.com 800-35-84473 81-83-14-16-10



DESCRIPCIÓN

COLCHONETA DE FIBRA DE VIDRIO

Aislamiento termoacústico flexible fabricado con fibra de vidrio laminada, con una barrera de vapor de vinyl de polipropileno reforzado. Ideal para aislamiento de techos metálicos. Presentación en rollos de 1.22 o 1.83 mts de ancho, de 30.48 mt de largo, en diferentes espesores.



POLY-ISO

Aislamiento para techos formado por un núcleo de celdas espumadas cerradas de polisocianurato en forma de placa a un revestimiento de fieltro negro reforzado con fibra de vidrio. Se maneja en medidas de 1.22 mt x 2.44 mt, en espesores de 1", 1.5" y 2".

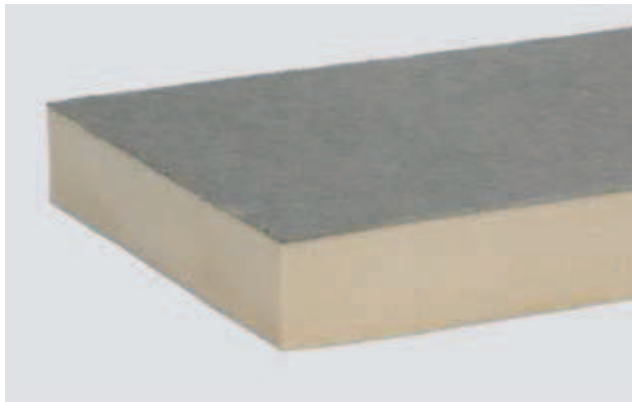

CABALLETE LISO

www.laminaseltigre.com 800-35-84473 81-83-14-16-10



DESCRIPCIÓN

Moldura que se ocupa en la unión de techos de 2 aguas. el largo es de 3.05 mt.



TABLA DE PESOS

www.laminaseltigre.com 800-35-84473 81-83-14-16-10

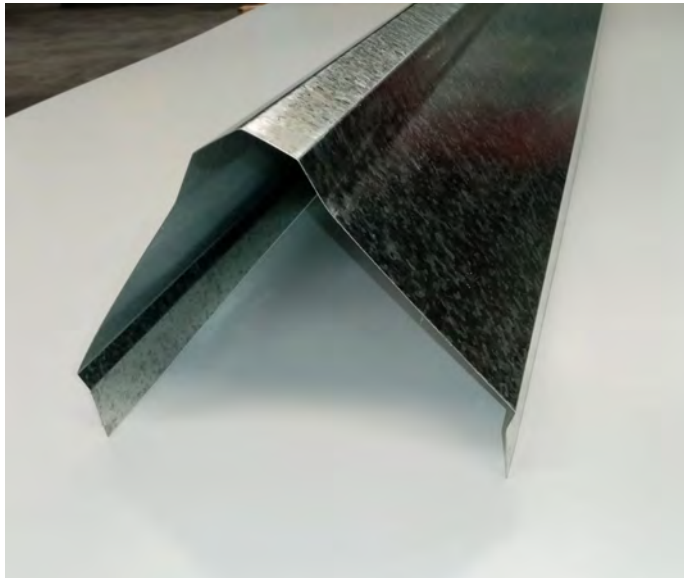
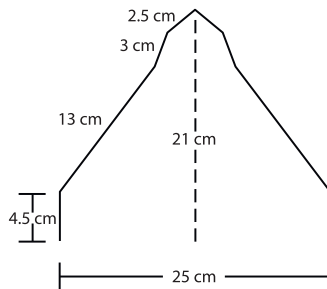

TABLA DE PESOS DE LÁMINA GALVANIZADA

Cal	ESPESOR	PESO EN HOJA EN KG.						KG. / PIE LINEAL		KG. / MTO.LINEAL	
	PULG.	3'X6'	3'X8'	3'X10'	3'X12'	4'X8'	4'X10'	3'	4'	3'	4'
10	0.1360	45.31	60.41	75.51	90.61	80.54	100.68	7.551	10.068	24.774	33.031
12	0.1061	35.34	47.12	58.90	70.68	62.82	78.53	5.890	7.853	19.322	25.763
14	0.0762	25.37	33.82	42.28	50.74	45.10	56.37	4.228	5.637	13.871	18.494
16	0.0613	20.40	27.20	34.00	40.80	36.26	45.33	3.400	4.533	11.154	14.872
18	0.0493	16.40	21.86	27.33	32.80	29.15	36.44	2.733	3.644	8.966	11.955
20	0.0374	12.43	16.58	20.72	24.86	22.10	27.62	2.072	2.762	6.767	9.062
22	0.0314	10.43	13.90	17.38	20.86	18.54	23.18	1.738	2.318	5.703	7.603
23	0.0254	8.76	11.68	14.60	17.52	13.92	17.40	1.460	1.740	4.609	6.145
24	0.0224	7.43	9.90	12.38	14.86	13.21	16.51	1.238	1.651	4.062	5.416
26	0.0194	6.43	8.57	10.71	12.85	11.43	14.29	1.071	1.429	3.515	4.686
28	0.0164	5.43	7.24	9.05	10.86	9.65	12.06	0.905	1.206	2.968	3.957
30	0.0135	4.46	5.95	7.44	8.93	7.93	9.91	0.744	0.991	2.439	3.252
32	0.0112	3.70	4.93	6.16	7.39	6.57	8.21	0.616	0.821	2.020	2.693

TABLA DE PESOS DE POLIN

	CALIBRE	LONGITUD	KG / PZ
3 EP 14	14	6	14.40
4 EP 14	14	4	14.00
4 EP 14	14	5	17.50
4 EP 14	14	6	21.00
5 EP 14	14	5	19.00
5 EP 14	14	6	22.80
6 EP 12	12	6	34.80
6 EP 14	14	6	25.20
8 EP 10	10	8	78.40
8 EP 12	12	8	61.60
8 EP 14	14	8	44.80
10 EP 10	10	10	112.00
10 EP 12	12	10	88.00
10 EP 14	14	10	64.00
12 EP 10	10	12	172.80
12 EP 12	12	12	133.20
12 EP 14	14	12	96.00

PESOS, MEDIDAS Y FACTORES DE CONVERSIÓN

www.laminaseltigre.com 800-35-84473 81-83-14-16-10



LONGITUD

1 Milímetro (mm)		= 0.03937 pulg.
1 Centímetro (cm)	= 10 mm	= 0.3937 pulg.
1 Metro (m)	= 100 cm	= 1.0936 yd
1 Pulgada (pulg)		= 25.4 mm
1 Pie	= 12 pulg.	= 0.3048 m
1 Yarda (yd)	= 3 pies	= 0.9144 m

PESO

1 Gramo (g)	= 1,000 mg	= 0.0353 mlb
1 Kilogramo (kg)	= 1,000 g	= 2.2046 lb
1 Tonelada (t)	= 1,000 kg	= 1.1023 g
1 Onza (oz)		= 28.350 g
1 Libra (lb)	= 16 oz	= 0.4536 kg
1 Tonelada corta (t.c.)	= 2,000 lb	= 0.9072 t
1 Tonelada larga (t.l)	= 2.240 lb	= 1.0161 t

Péso

Kilogramos

Libras

kg / lb

0.454	1	2.205
2.268	5	11.023
4.536	10	22.046
22.680	50	110.231
45.359	100	220.462

RECOMENDACIONES

www.laminaseltigre.com 800-35-84473 81-83-14-16-10



ALMACENAJE

Los productos deben almacenarse invariablemente:

- Bajo techo
- En un lugar seco y ventilado
- Sobre tarimas o barrotes, para evitar el contacto con el agua o la humedad del suelo
- NUNCA** directamente sobre el piso

En caso de no encontrar un lugar adecuado, deberá improvisarse uno utilizando lonas impermeables pero sin que tengan contacto directo sobre la lámina.

APILADO

- Utilice barrotes con separación mínima de un metro.
- Cuide que exista espacio entre los rollos; los rollos pequeños siempre se colocan arriba.
- No utilice plástico para cubrir los paquetes ya que generan humedad por falta de ventilación.
- No almacene detergentes, solventes, ácidos o alcalinos, como cemento o yeso, junto con los productos aquí descritos (lámina galvanizada, zintroalum y pintada).

EJEMPLOS DE APILADO





PLANTA MILIMEX

AV. ÁGUILA AZTECA #121
PARQUE INDUSTRIAL MILIMEX, CIÉNEGA DE FLORES, N.L.
TEL. 800-35-84473

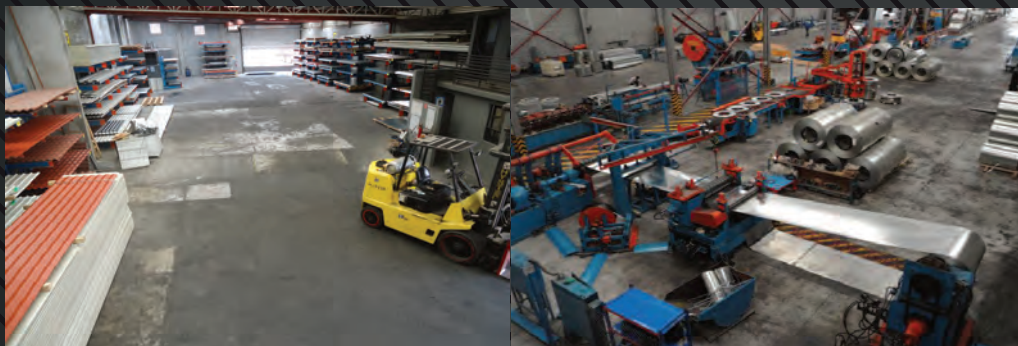

SUCURSAL

ANTONIO GARZA VILLARREAL #113
COL. EL MEZQUITAL, C.P. 66630 APODACA, N.L.
TEL. 81-83-14-16-10

DESCARGA NUESTRO CATÁLOGO DIGITAL

